

Technical data

Compensating device and Maxi profile	176
Vertical windows and doors	177 - 183
Skylights	184 - 187
Vertical special shapes, taut	188 - 192
Vertical special shapes, free-hanging	193 - 195
Fixed vertical special shapes	196
Ceiling and conservatory blinds - Standard	197 - 198
Ceiling and conservatory blinds - Special shapes	199 - 202

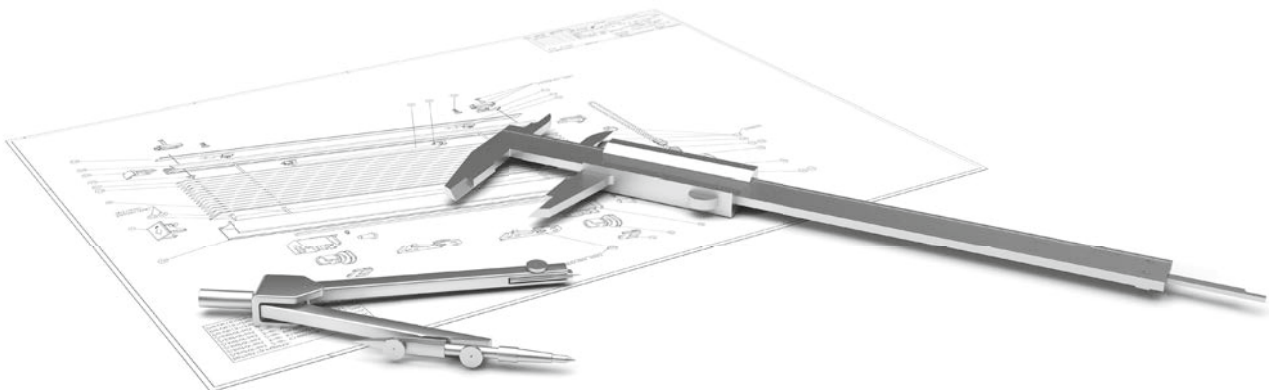

Technical
data

Compensating device and Maxi profile

for models 11-8120, 11-8220, 11-8222, 11-8320, 11-8370, 11-7120, 11-7220, 11-7370, 11-7122, 11-7223, 11-7372

Compensating device

Based on the principle of bridge construction, the MHZ engineers have developed an aluminium profile, which allows pressure to build up on the inside of the profile and thus straightens it. The operating profiles can be aligned perfectly straight using this system, making unit widths of 180 cm (max. unit height 200 cm) possible without any sagging.

The pleated blind units are adjusted at the factory. Retrospective adjustments can be made by the customer at any time using the Allen key provided.

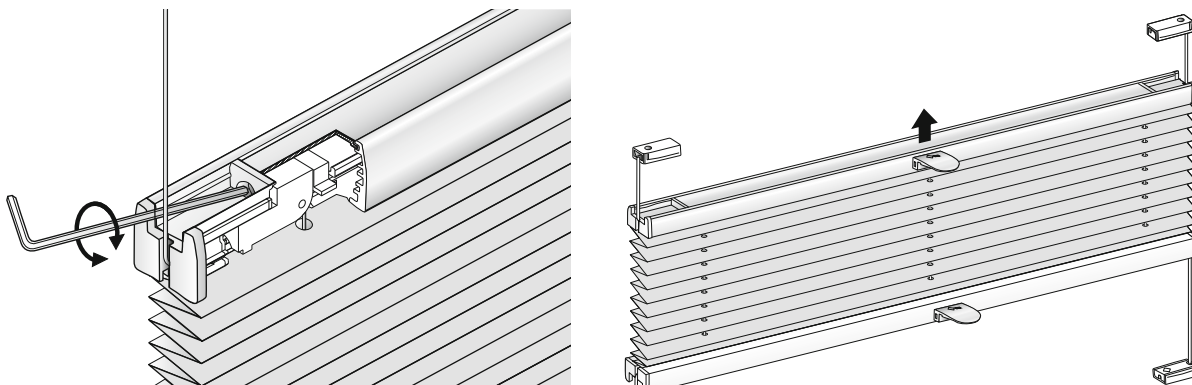

The compensating device is recommended for unit widths greater than 120 cm and can be only used in combination with the Maxi profile. The compensating device can only be retrofitted at the factory.

Caution! Units with a compensating device should only be cleaned using a damp cloth. Mechanical parts must not come into contact with alkaline solutions or water.

Maxi profile

The Maxi profile is a higher operating profile to be used with the above models and features greater stability. It can be used if required for unit widths of 120 cm or more.

Smaller units can also be equipped with the Maxi profile for orders in which several units with different widths are to be installed side by side. Please specify when ordering.

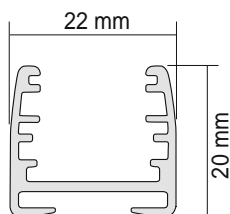

Maxi profile

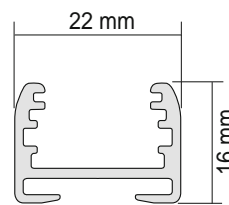

Standard operating profile

Model 11-8120, 11-8220, 11-8222

Vertical windows and doors: Blind fixed at the top · Blind, freely movable

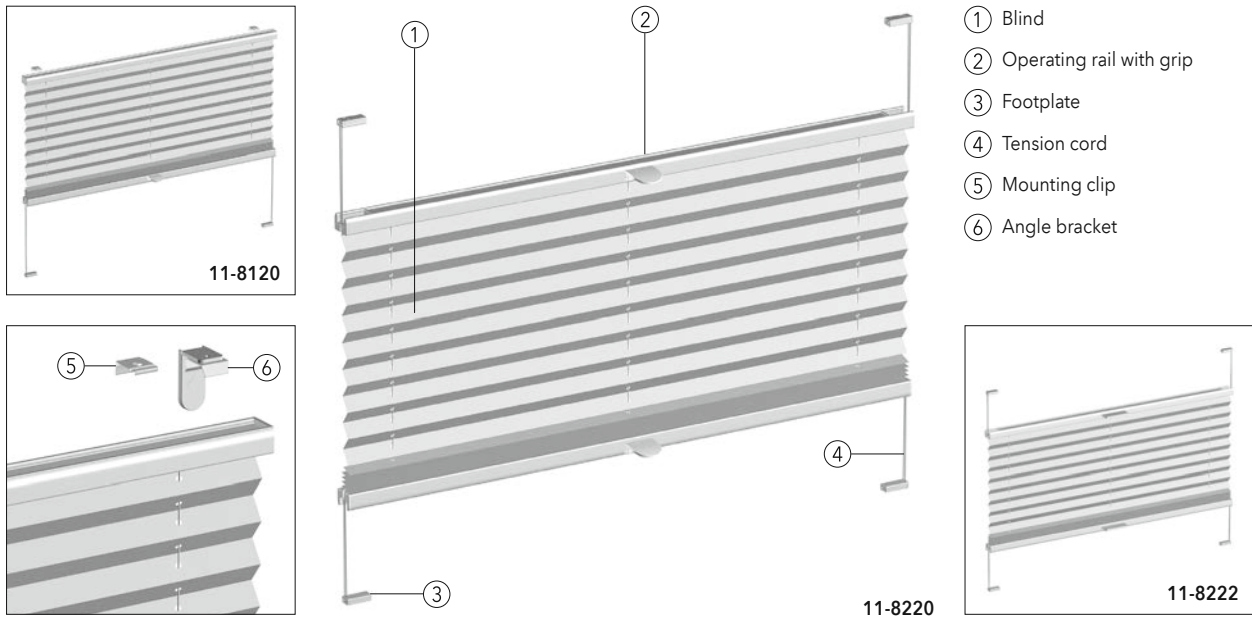

Technical data

Model:	11-8120 Taut pleated blind with blind fixed at the top 11-8220 Taut pleated blind with freely movable blind 11-8222 Taut pleated blind with freely movable blind and aluminium grip												
Description:	Blind individually adjustable by moving the operating rails. Head and operating rail made of extruded aluminium. Pleated blind in various qualities, see MHZ collection. Colour of tension cords matches the blind. Particularly suitable for glazing bead installation with tilt & turn windows, see p. 25. Parallel blind guidance by means of laterally taut guide cord.												
Dimensions:	Min. width 20 cm, max. width 150 cm (for units with widths of 120 cm - 150 cm: Maxi profile recommended), max. height 240 cm, from widths of 150.1 cm to 180 cm, only in combination with Maxi profile and compensating device, max. height 200 cm.												
Hardware colours:	100 silver anodised E6/EV1 171 white powder-coated RAL 9016 372 bronze anodised E6/3145 650 anthracite powder-coated similar to DB 703 670 black powder-coated RAL 9005												
Bundle heights:	<table border="1"> <thead> <tr> <th>Unit height up to (cm)</th> <th>50</th> <th>100</th> <th>150</th> <th>220</th> <th>240</th> </tr> </thead> <tbody> <tr> <td>Bundle height approx. (cm)*</td> <td>5</td> <td>6</td> <td>7</td> <td>8</td> <td>9</td> </tr> </tbody> </table> <p>* Unit with Maxi profile + approx. 1 cm</p>	Unit height up to (cm)	50	100	150	220	240	Bundle height approx. (cm)*	5	6	7	8	9
Unit height up to (cm)	50	100	150	220	240								
Bundle height approx. (cm)*	5	6	7	8	9								
Fabrics:	See MHZ Collection.												
Operation:	Open and close using operating rail(s). Rails secured at any desired position. An operating rod is optionally available for units difficult to reach. Units with widths of 140.1 cm or more are supplied with 2 or 4 grips. Other versions are available on request.												
Special equipment:	Aluminium grip (only for 11-8120) Maxi profile (see page 176) Compensating device (see page 176) Swivel-mounted grip (only for 11-8220, 11-8120)												
Installation:	11-8120 Ceiling installation (standard) with clip and footplates. Wall installation with angle or glazing bead brackets for front installation and clamp brackets (surcharge applies). 2 brackets up to a width of 64.9 cm, 3 brackets above a width of 65 cm. 11-8220, 11-8222 Ceiling installation (standard) with footplates. Angle or glazing bead brackets for front installation, clamp brackets, window clip and adhesive set (surcharge applies). See pages 26 - 32 for brackets and accessories.												

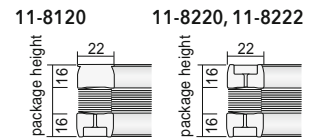
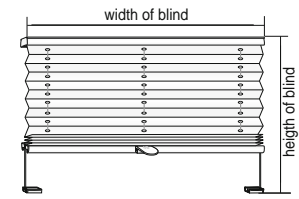

11-8120, 11-8220, 11-8222

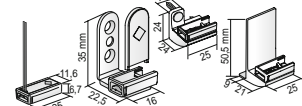
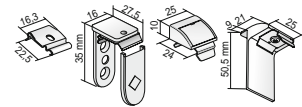

Only 11-8220, 11-8222

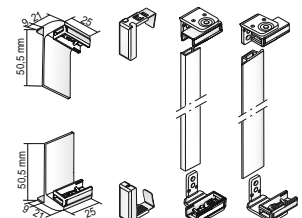

Technical data

Model 11-8320, 11-8370

Vertical windows and doors: 2 blinds

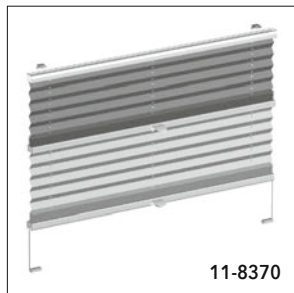

11-8370

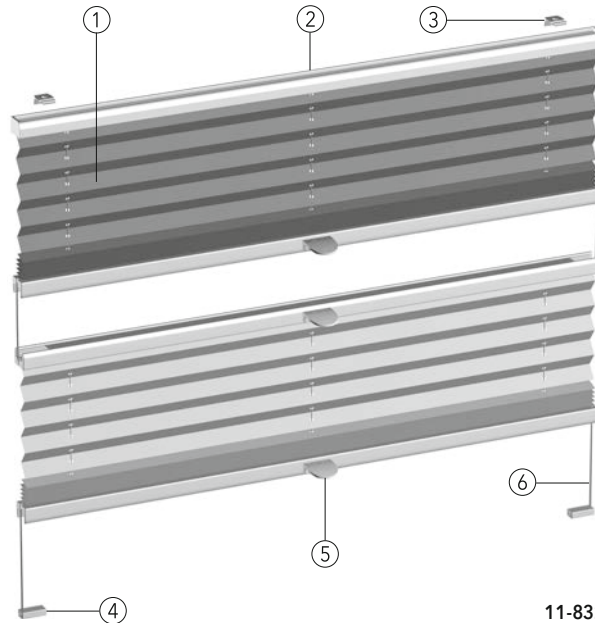
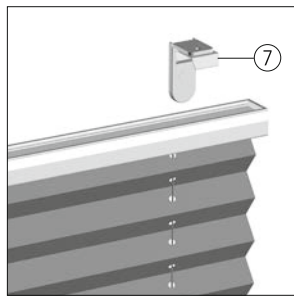

11-8320

- ① Blind
- ② Head rail
- ③ Mounting clip
- ④ Footplate
- ⑤ Operating rail with grip
- ⑥ Tension cord
- ⑦ Angle bracket

Technical data

Model: 11-8320 Taut pleated blind with two blinds, fixed at the top, freely movable at the bottom
 11-8370 Taut pleated blind with two blinds, fixed at the top

Description: Blind individually adjustable by moving the operating rails. Head and operating rail made of extruded aluminium. Pleated blinds in various qualities, see MHZ collection. Colour of tension cords matches the blinds. Particularly suitable for glazing bead installation for tilt & turn windows. Parallel blind guidance by means of laterally taut guide cord.

Dimensions: Min. width 20 cm, max. width 120 cm, max. height 220 cm, from widths of 120.1 cm to 150 cm (Maxi profile recommended), max. height 150 cm, from width 150.1 cm to 160 cm only in combination with Maxi profile and compensating device, max. height 150 cm.

Hardware colours: 100 silver anodised E6/EV1 171 white powder-coated RAL 9016
 372 bronze anodised E6/3145 650 anthracite powder-coated similar to DB 703
 670 black powder-coated RAL 9005

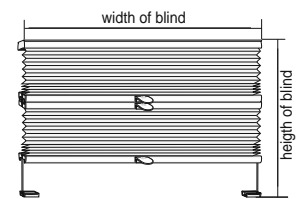

Bundle heights:	Unit height up to (cm)	50	100	150	220
11-8320 Bundle height approx. (cm)*		8	9	10	12.5
11-8370 Bundle height approx. (cm)*		7	8	9	10

* Unit with Maxi profile + c. 1 cm

Fabrics: See MHZ Collection.

Operation: Open and close using operating rails. Rails secured at any desired position. An operating rod is optionally available for units difficult to reach. Units with widths of 140.1 cm or more are supplied with 4 or 6 grips. Other versions are available on request.

Special equipment: Aluminium grip
 Grip, swivel-mounted
 Compensating device (see page 176)

Installation: Ceiling installation (standard) with clip and footplates. Wall installation with angle or glazing bead brackets for front installation and clamp brackets (surcharge applies). 2 brackets up to a width of 64.9 cm, 3 brackets above a width of 65 cm. See pages 26 - 32 for brackets and accessories.

Note:  **11-8320:** Magnets are installed as standard in the two profiles that run together to prevent a light gap (see figure), which would otherwise be unavoidable. As an option, the compensating device with Maxi profile can be installed in units with a width of 120 cm to 150 cm. Only possible with compensating device from unit widths above 150.1 cm. Magnets can produce a far-ranging, powerful magnetic field. Please observe safety clearance and instructions. Units should only be cleaned using a damp cloth. Mechanical parts must not come into contact with alkaline solutions or water.

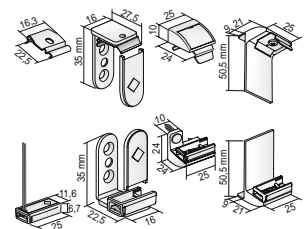
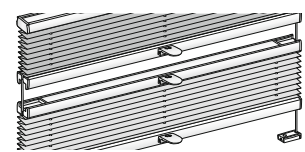
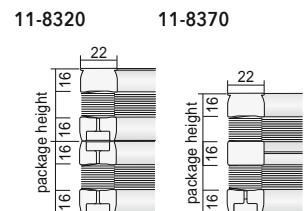

Model 11-8110

Vertical windows and doors: Cord operation

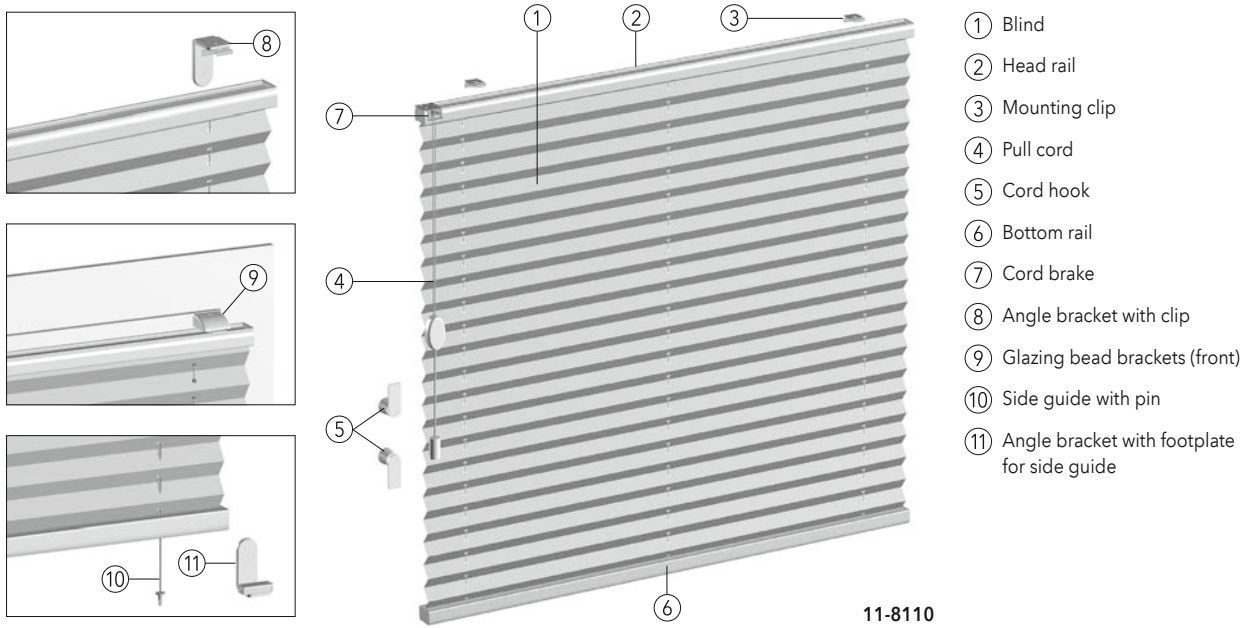

11-8110

Technical data

Model:	11-8110 Free-hanging pleated blind with cord operation, with optional side guide				
Description:	Cord operation with integrated lateral cord brake. Head rail and bottom rail made of extruded aluminium. Pleated blind in various qualities, see MHZ collection, colour of the pull cords matches the blind.				
Dimensions:	Min. width 30 cm, max. width 220* cm, max. height 260 cm * depends on fabric width, see collection part				
Hardware colours:	100 silver anodised E6/EV1	171 white powder-coated RAL 9016			
	372 bronze anodised E6/3145	650 anthracite powder-coated similar to DB 703			
	670 black powder-coated RAL 9005				
Bundle heights:	Unit height up to (cm)	50	100	150	200
	Bundle height approx. (cm)	5	6	7	8
Fabrics:	See MHZ Collection.				
Operation:	Lift and lower with a pull cord, secured in position via the cord brake. Operating side left or right. Standard operation length (L) 100 cm, other heights available on request. Cord hooks included.				
Child safety:	The safety tassel for child safety comes pre-installed on the cord. After operation, the pull cord and safety tassel must be wrapped around the cord hook, see page 215.				
Special equipment:	Side guide runs through the first punched hole (5 cm from the outside)				
Installation:	Ceiling installation (standard) with clip. Wall installation with angle or glazing bead brackets for front installation or clamp brackets (surcharge applies). 2 brackets up to a width of 99.9 cm, 3 brackets above a width of 100 cm. See pages 38 - 41 for brackets and accessories.				

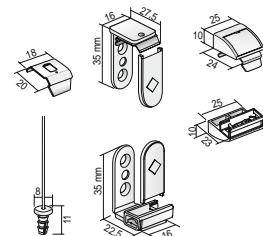
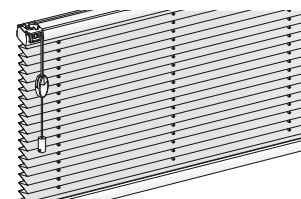
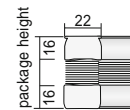
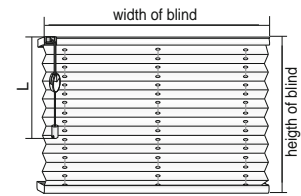

Technical data

Model 11-8130

Vertical windows and doors: Chain operation

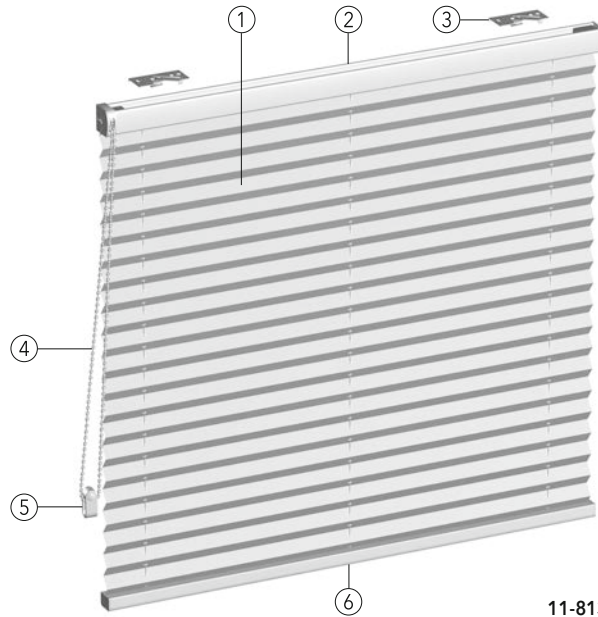
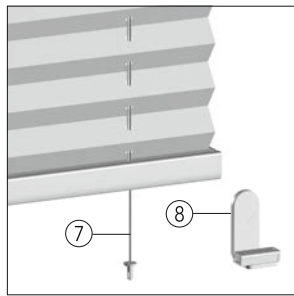

- ① Blind
- ② Head rail
- ③ Tension lever bracket
- ④ Operating chain
- ⑤ Safety tensioner
- ⑥ Bottom rail
- ⑦ Side guide with pin
- ⑧ Angle brackets with Footplate

11-8130

Technical data

Model: 11-8130 Free-hanging pleated blind with chain pull, with optional side guide. Lateral gear with chain operation, chain exit at front. Pull tapes colour-matched to blind.

Description: Head rail and bottom rail made of extruded aluminium. Pleated blind in various qualities, see MHZ collection.

Dimensions: Min. width 35 cm, max. width 230* cm, max. height 260 cm
** depends on the fabric width, see collection part

Hardware colours: 100 silver anodised E6/EV1 171 white powder-coated RAL 9016
372 bronze anodised E6/3145 650 anthracite powder-coated similar to DB 703
670 black powder-coated RAL 9005

Bundle heights:	Unit height up to (cm)	50	100	150	200	260
	Bundle height approx. (cm)	6	7	8	9	10

Fabrics: See MHZ Collection.

Operation: Lift and lower via operating chain. Blind secured automatically in position. Operating side left or right. Operation length (L) from 50 cm to 150 cm in 10 cm increments (standard 100 cm), operation length from 150.1 cm to 300 cm in 25 cm increments. Other operation lengths available on request (surcharge applies). Please also note information on page 215.

Child safety: The safety tensioner is supplied pre-fitted on the operating chain, also see page 215. **Caution:** Be sure to fit in correct direction and to keep chain taut. Correct positioning of the safety tensioner must be checked regularly and, in the case of doubt, re-adjusted.

Special equipment: Metal chain
Side guide runs through the separate punched hole (2 cm from the outside)

Installation: Wall and ceiling installation with tension lever brackets. Clamp bracket (surcharge applies). 2 brackets up to a width of 149.9 cm, 3 brackets above a width of 150 cm. See pages 47 - 49 for brackets and accessories.

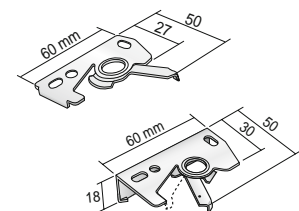
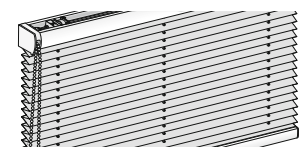
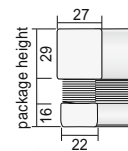
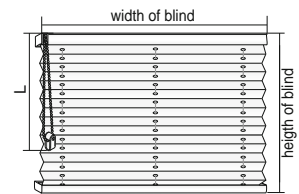

Model 11-8140

Vertical windows and doors: Electric drive 24 V

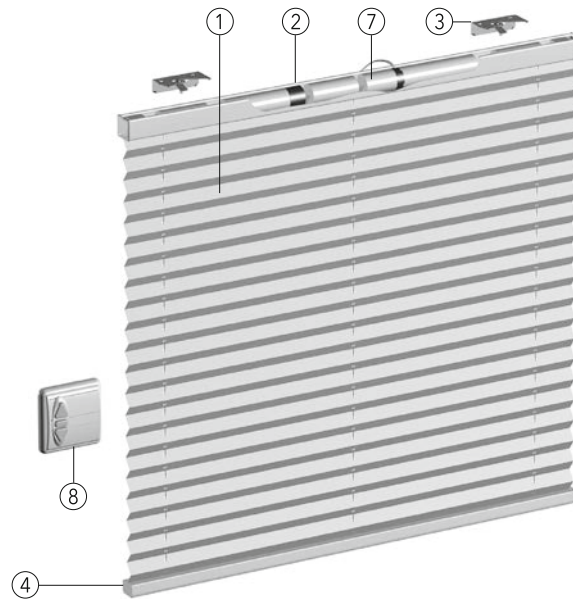
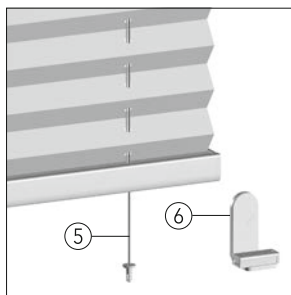

- ① Blind
- ② Head rail
- ③ Tension lever bracket
- ④ Bottom rail
- ⑤ Side guide with pin
- ⑥ Angle brackets with Footplate
- ⑦ Electric drive 24 V
- ⑧ Switch combination not included

11-8140

Technical data

Model: 11-8140 Free-hanging pleated blind with electric drive 24 V, with optional side guide. Electric drive 24 V, mounted centrally in the head rail, with automatic end position switch-off.

Description: Head rail and bottom rail made of extruded aluminium. Pleated blind in various qualities, see MHZ collection. Model is suitable for damp locations (DIN EN 13120, L1 and max. L2, i.e. well-heated and ventilated living spaces that are not overcrowded, including kitchens and bathrooms).

Dimensions: Min. width 75 - 95 cm, max. height 170 cm, width 95.1 cm - max. 230* cm, max. height 260 cm
** depends on the fabric width, see collection part

Hardware colours: 100 silver anodised E6/EV1 171 white powder-coated RAL 9016
372 bronze anodised E6/3145 650 anthracite powder-coated similar to DB 703
670 black powder-coated RAL 9005

Bundle heights:	Unit height up to (cm)	50	100	150	200	260
	Bundle height approx. (cm)	6	7	8	9	10

Fabrics: See MHZ Collection.

Operation: Lifting and lowering by electric drive 24 V. Various control options by lock switch, radio remote control, timer and light sensor. For electrical accessories and control options, see Electrical Accessories Price List.

Special equipment: Side guide runs through the separate punched hole (2 cm from the outside)

Installation: Wall and ceiling installation with tension lever brackets. Clamp bracket (surcharge applies). 2 brackets up to a width of 149.9 cm, 3 brackets above a width of 150 cm. See pages 47 - 49 for brackets and accessories.

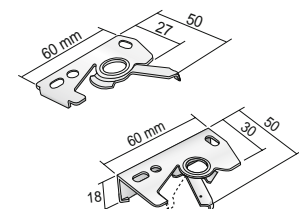
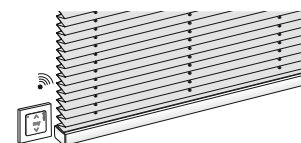
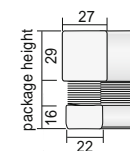
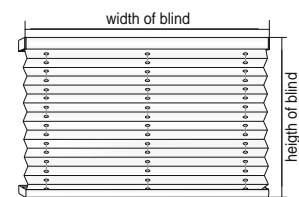

Technical data

Model 11-8145

Vertical windows and doors: Battery-operated radio drive 12 V

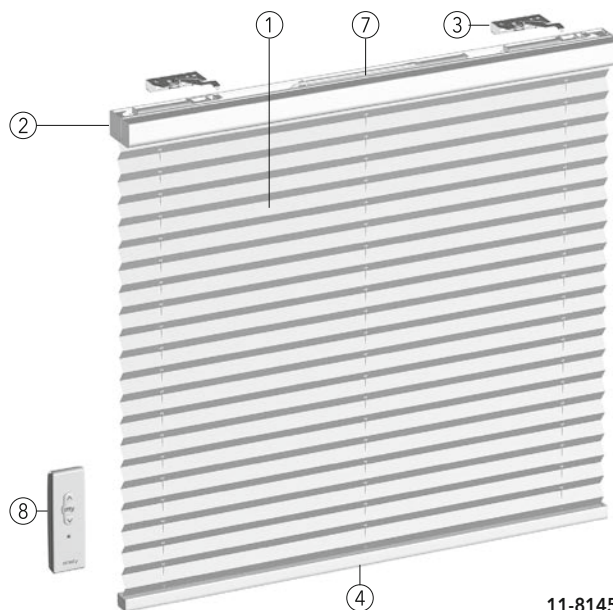
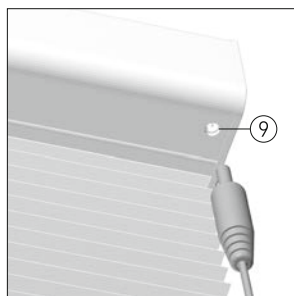
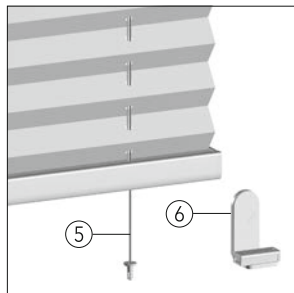

- ① Blind
- ② Head rail
- ③ Tension lever bracket, long
- ④ Bottom rail
- ⑤ Side guide with pin
- ⑥ Angle brackets with Footplate
- ⑦ Battery-operated radio drive 12 V
- ⑧ Radio remote control, 1-channel, included
- ⑨ Charging socket

11-8145

Technical data

Model: 11-8145 Free-hanging pleated blind with battery-operated radio drive 12 V, with optional side guide. Radio drive 12 V at centre of head rail, with integrated radio receiver and automatic end position switch-off, battery mounted at front. Charging socket on right as standard, or on left if requested.

Description: Single or group operation. Model is suitable for damp locations (DIN EN 13120, L1 and max. L2, i.e. well-heated and ventilated living spaces that are not overcrowded, including kitchens and bathrooms). Head rail and bottom rail made of extruded aluminium. Pleated blind in various qualities, see MHZ collection.

Dimensions: Min. width 75 - 95 cm, max. height 170 cm, width 95.1 cm - max. 230* cm, max. height 260 cm
** depends on the fabric width, see collection part

Hardware colours: 100 silver anodised E6/EV1 171 white powder-coated RAL 9016
372 bronze anodised E6/3145 650 anthracite powder-coated similar to DB 703
670 black powder-coated RAL 9005

Bundle heights:	Unit height up to (cm)	50	100	150	200	260
	Bundle height approx. (cm)	6	7	8	9	10

Fabrics: See MHZ Collection.

Operation: Raised and lowered using radio drive 12 V, incl. rechargeable battery and Situo 1 RTS/Situo 5 RTS II radio remote control (included). Charger not included. Radio remote control provides additional range of control options. For electrical accessories, see the Electrical Accessories Price List. Delivery condition: battery is partially charged. Fully charge battery for max. operating period.

Special equipment: Side guide runs through the separate punched hole (2 cm from the outside)

Installation: Wall and ceiling installation with long tension lever brackets. 2 brackets up to a width of 149.9 cm, 3 brackets above a width of 150 cm. See pages 54 - 55 for brackets and accessories.

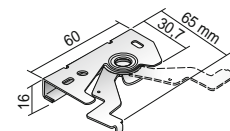
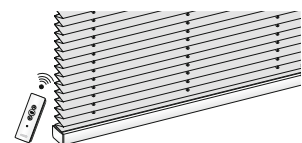
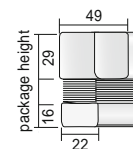
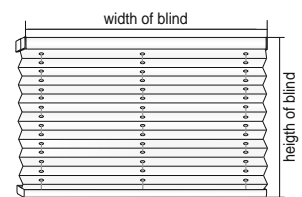

Model 11-8148

Vertical windows and doors: Electric radio drive 18 V/battery-operated radio drive 18 V

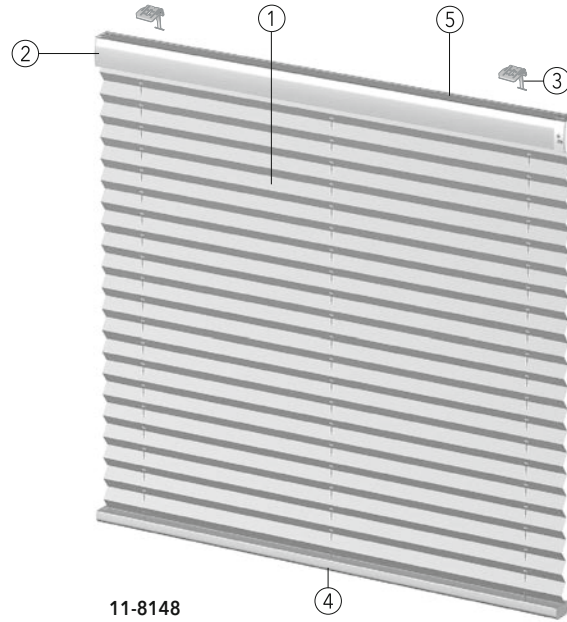
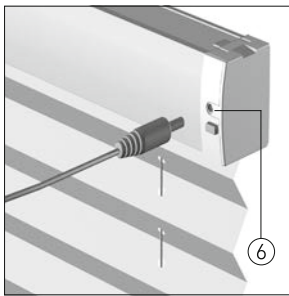

- ① Blind
- ② Head rail
- ③ Bracket mount
- ④ Bottom rail
- ⑤ Battery-operated radio drive 18 V
- ⑥ Charging socket

11-8148

Technical data

Model: 11-8148 Free-hanging pleated blind with electric radio drive 18 V/battery-operated radio drive 18 V at the side, always the right, in the head rail, charging socket as standard on the right.

Description: Various control options, smart home compatible. Model is suitable for damp locations (DIN EN 13120, L1 and max. L2, i.e. well-heated and ventilated living spaces that are not overcrowded, including kitchens and bathrooms). Head rail and bottom rail made of extruded aluminium. Pleated blind in various qualities, see MHZ collection.

Dimensions: Min. width 45 cm* - max. 230** cm, max. height 260 cm
 ** Where unit width is 45 - 83 cm, battery outside of the head rail, installation using magnetic holder;
 above a unit width of 83.1 cm battery integrated in the head rail
 ** depends on the fabric width, see collection part

Hardware colours: 100 silver anodised E6/EV1 171 white powder-coated RAL 9016
 372 bronze anodised E6/3145 650 anthracite powder-coated similar to DB 703
 670 black powder-coated RAL 9005

Bundle heights:	Unit height up to (cm)	50	100	150	200	260
	Bundle height approx. (cm)	6	7	8	9	10

Fabrics: See MHZ Collection.

Operation: Raised and lowered using electric radio drive 18 V/battery-operated radio drive 18 V. Charger not included. Various control options, smart home compatible. For electrical accessories and control options, see Electrical Accessories Price List.

Special equipment: Side guide runs through the punched holes

Installation: Wall and ceiling installation using bracket mount. See page 61 for brackets and accessories.

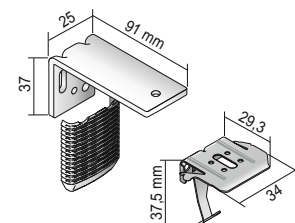
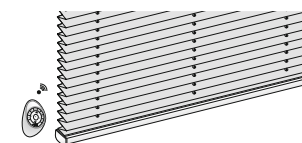
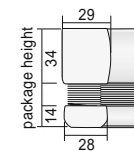
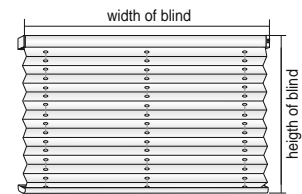

Technical data

Model 11-7120, 11-7220, 11-7370

For skylights: Blind fixed at the top · Blind, freely movable · 2 blinds

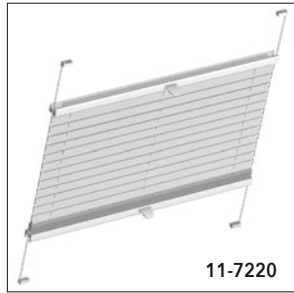

11-7220

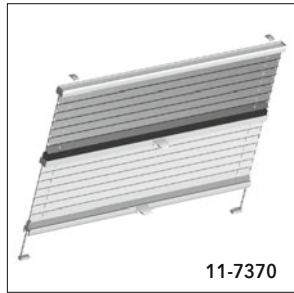

11-7370

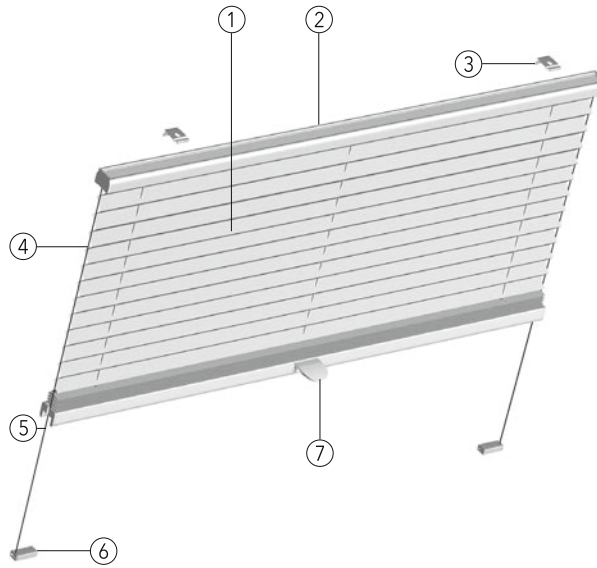

11-7120

- ① Blind
- ② Head rail
- ③ Mounting clip
- ④ Tension wire
- ⑤ Guide cord
- ⑥ Footplate
- ⑦ Operating rail with grip

Technical data

Model:	<p>11-7120 Taut pleated blind for skylights with blind fixed at the top</p> <p>11-7220 Taut pleated blind for skylights with freely movable blind</p> <p>11-7370 Taut pleated blind for skylights with two blinds, fixed at the top</p>																
Description:	<p>Blind individually adjustable by moving the operating rails. Head, central and bottom rail made of extruded aluminium. Pleated blind in various qualities, see MHZ collection. Colour of tension cords matches the blind. Black-coated tension wires at the sides guide the pleated blind parallel to the skylight.</p>																
Dimensions:	<p>Min. width 20 cm, max. width 150 cm only in combination with Maxi profile and compensating device, max. height 150 cm</p> <p>Units with a width of 120 cm to 150 cm with compensating device.</p>																
Hardware colours:	<table border="0"> <tr> <td>100 silver anodised E6/EV1</td> <td>171 white powder-coated RAL 9016</td> </tr> <tr> <td>372 bronze anodised E6/3145</td> <td>650 anthracite powder-coated similar to DB 703</td> </tr> <tr> <td colspan="2">670 black powder-coated RAL 9005</td> </tr> </table>	100 silver anodised E6/EV1	171 white powder-coated RAL 9016	372 bronze anodised E6/3145	650 anthracite powder-coated similar to DB 703	670 black powder-coated RAL 9005											
100 silver anodised E6/EV1	171 white powder-coated RAL 9016																
372 bronze anodised E6/3145	650 anthracite powder-coated similar to DB 703																
670 black powder-coated RAL 9005																	
Bundle heights:	<table border="1"> <thead> <tr> <th>Unit height up to (cm)</th> <th>50</th> <th>100</th> <th>150</th> </tr> </thead> <tbody> <tr> <td>11-7120 Bundle height approx. (cm)</td> <td>5</td> <td>6</td> <td>7</td> </tr> <tr> <td>11-7220 Bundle height approx. (cm)</td> <td>5</td> <td>6</td> <td>7</td> </tr> <tr> <td>11-7370 Bundle height approx. (cm)</td> <td>7</td> <td>8</td> <td>10</td> </tr> </tbody> </table>	Unit height up to (cm)	50	100	150	11-7120 Bundle height approx. (cm)	5	6	7	11-7220 Bundle height approx. (cm)	5	6	7	11-7370 Bundle height approx. (cm)	7	8	10
Unit height up to (cm)	50	100	150														
11-7120 Bundle height approx. (cm)	5	6	7														
11-7220 Bundle height approx. (cm)	5	6	7														
11-7370 Bundle height approx. (cm)	7	8	10														
Note:	<p>Thanks to the VELUX system brackets, the light gap is approx. 8 mm on each side with VELUX windows. Note position of window grip. If required, the grip of the pleated blind can be off-centre (specify when ordering).</p>																
Fabrics:	See MHZ Collection.																
Operation:	<p>Open and close using operating rails. Rails secured at any desired position. An operating rod is optionally available for units difficult to reach. Units with widths of 140.1 cm or more are supplied with 2 or 4 grips, depending on the model. Other versions are available on request.</p>																
Special equipment:	<p>Aluminium grip</p> <p>Compensating device</p>																
Installation:	<p>11-7120, 11-7370 Ceiling installation (standard) with clips. Wall installation with angle brackets (surcharge applies).</p> <p>11-7220 Ceiling installation (standard) with footplates. Wall installation with angle brackets (surcharge applies). See pages 87 - 89 for brackets and accessories.</p>																

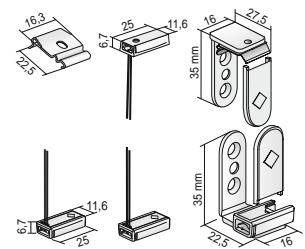
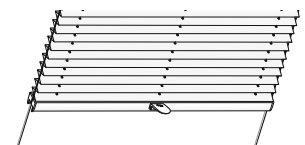
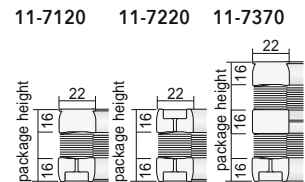
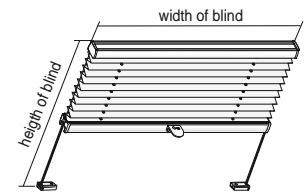

Model 11-7122, 11-7223, 11-7372

For skylights: Blind fixed at the top · Blind, freely movable · 2 blinds

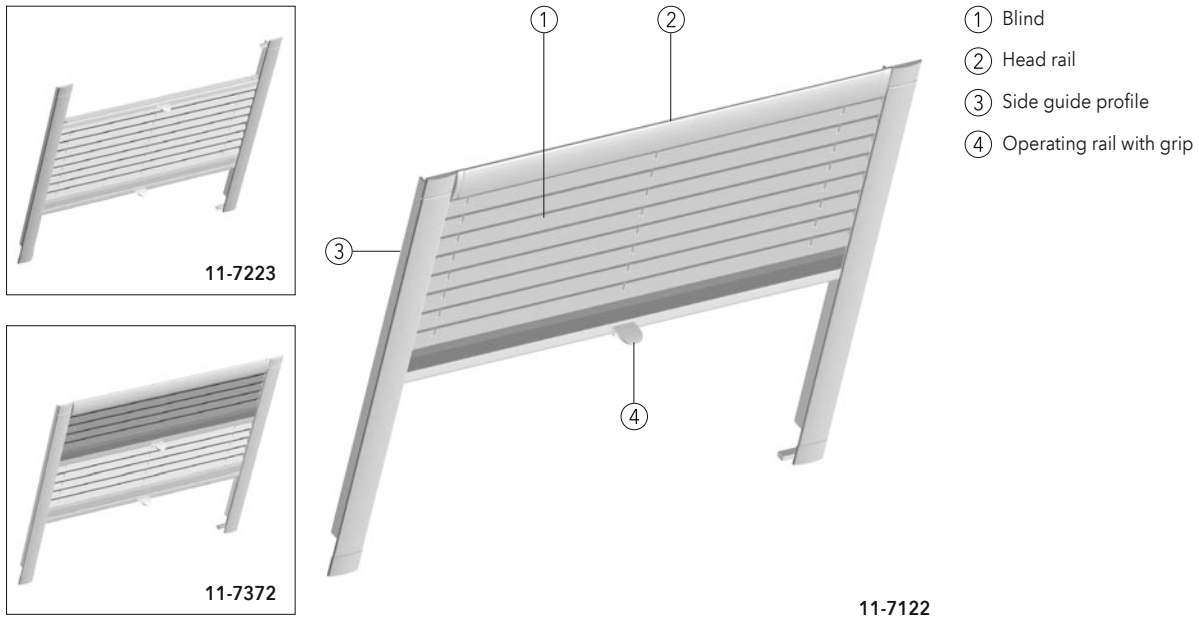

Technical data

Model:
11-7122 Taut pleated blind for skylights with blind fixed at the top and side guide profiles
11-7223 Taut pleated blind for skylights with freely movable blind and side guide profiles
11-7372 Taut pleated blind for skylights with two blinds, fixed at the top and with side guide profiles

Description: Blind individually adjustable by moving the operating rails. Head and bottom rails and side guide rails made from extruded aluminium. Pleated blind in various qualities, see MHZ collection. Colour of tension cords matches the blind. Side guide rails to cover the light gap at the side.

Dimensions: Min. width 20 cm, max. width 150 cm only in combination with Maxi profile and compensating device, max. height 150 cm
 Units with a width of 120 cm to 150 cm with compensating device.

Hardware colours:
 100 silver anodised E6/EV1
 171 white powder-coated RAL 9016

Bundle heights:	Unit height up to (cm)	50	100	150
11-7122 Bundle height approx. (cm)		5	6	7
11-7223 Bundle height approx. (cm)		5	6	7
11-7372 Bundle height approx. (cm)		7	8	10

Note: Note position of window grip. If required, the grip of the pleated blind can be off-centre (specify when ordering). Not possible for HEIM & HAUS skylights.

Fabrics: See MHZ Collection.

Operation: Open and close using operating rails. Rails secured at any desired position. An operating rod is optionally available for units difficult to reach. Units with widths of 140.1 cm or more are supplied with 2 or 4 grips, depending on the model. Other versions are available on request.

Special equipment: Aluminium grip
 Compensating device

Installation: Installation via skylight brackets. Screw the side guiding profiles to the side of the frame. See pages 92 - 93 for further accessories.

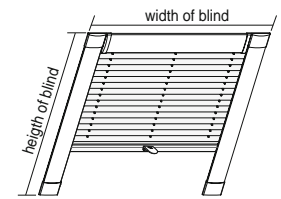

11-7122 11-7223 11-7372

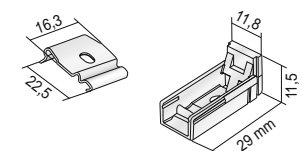
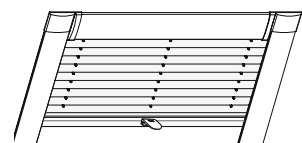
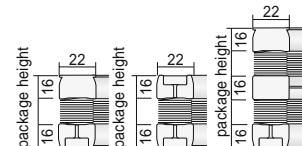

Technical data

Model 11-7145

For skylights: Blind fixed at the top with battery-operated radio drive 12 V, incl. solar panel

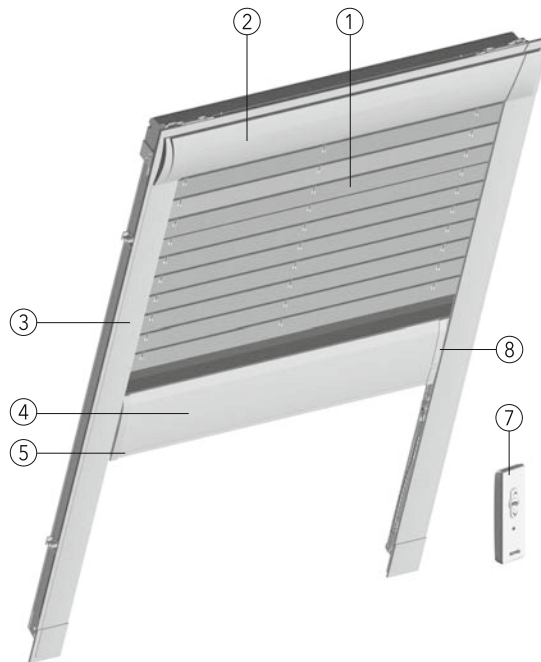
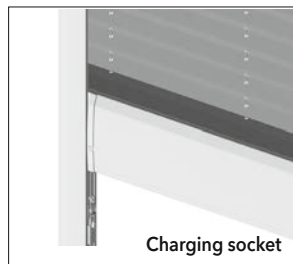
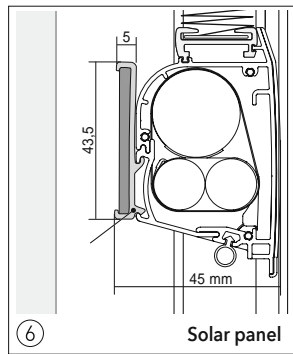

- ① Blind
- ② Head rail
- ③ Side guide profile
- ④ Motor profile
- ⑤ Battery-operated radio drive 12 V (integrated in movable motor profile)
- ⑥ Solar panel (on back of motor profile, pointing towards the window)
- ⑦ Radio remote control, 1-channel (included)
- ⑧ Charging socket (concealed, if required, charger not included)

11-7145

Technical data

Model: 11-7145 Taut pleated blind for skylights with blind fixed at the top and side guide profiles, battery-operated radio drive 12 V, incl. solar panel for an independent power supply.

Description: Battery-operated radio drive 12 V integrated in movable motor profile, with integrated radio receiver and automatic end position switch-off. Single or group operation. Model is suitable for damp locations (DIN EN 13120, L1 and max. L2, i.e. well-heated and ventilated living spaces that are not overcrowded, including kitchens and bathrooms) Solar panel on back of movable motor profile, pointing towards the window. Charging socket concealed and integrated in motor profile (if required). Motor profile runs in side guide profiles. Rails made of extruded aluminium. Pleated blind in various qualities, see MHZ collection.

Dimensions: Min. width 40 cm, max. width 150 cm, min. height 40 cm, max. height 150 cm

Hardware colours: 100 silver anodised E6/EV1
171 white powder-coated RAL 9016

Bundle heights:	Unit height up to (cm)	50	100	150
11-7145	Bundle height approx. (cm)	12	13	14

Note: Not possible for HEIM & HAUS skylights.

Fabrics: See MHZ Collection.

Operation: Raised and lowered using radio drive 12 V, incl. rechargeable battery, solar panel and Situo 1 RTS/Situo 5 RTS II radio remote control (included). Charger not included. Radio remote control provides additional range of control options. For electrical accessories, see the Electrical Accessories Price List.

Installation: Installation via skylight brackets. Screw the side guiding profiles to the side of the frame. See pages 100 - 101 for further accessories.

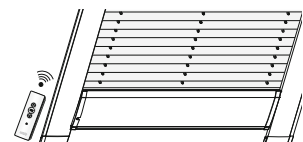
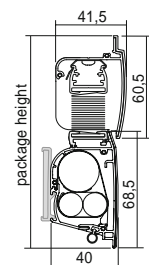
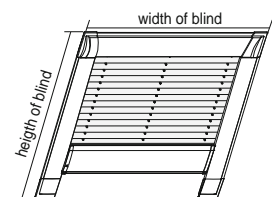

Model 11-7225

For skylights: Blind freely movable, operating rail with grip recess

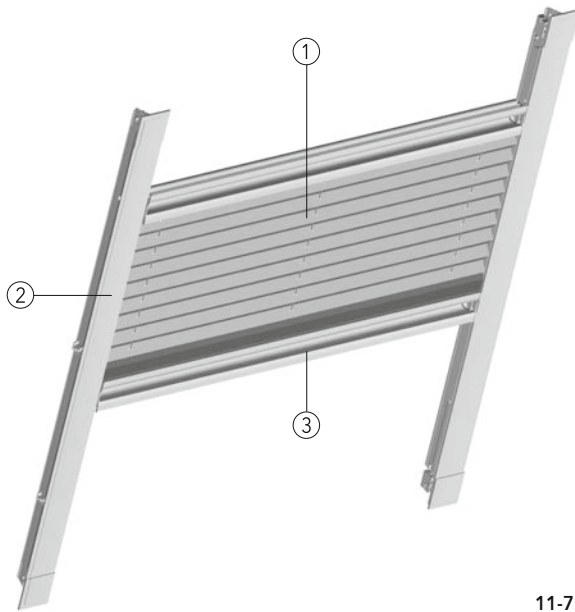

- ① Blind
- ② Side guide profile
- ③ Operating rail with continuous grip recess

11-7225

Technical data

Model:	11-7225 Taut pleated blind for skylights with freely movable blind and side guide profiles								
Description:	Blind individually adjustable by moving the operating rails. Operating rail with continuous grip recess along entire unit width. Operating rails run in side guide profiles. Side guide profiles made of extruded aluminium. Pleated blind in various qualities, see MHZ collection. Colour of tension cords matches the blind. Side guide rails to cover the light gap at the side.								
Dimensions:	Min. width 20 cm, max. width 150 cm, max. height 150 cm.								
Hardware colours:	100 silver anodised E6/EV1 171 white powder-coated RAL 9016								
Bundle heights:	<table border="1" style="width: 100%; border-collapse: collapse;"> <thead> <tr> <th style="text-align: left;">Unit height up to (cm)</th> <th style="text-align: center;">50</th> <th style="text-align: center;">100</th> <th style="text-align: center;">150</th> </tr> </thead> <tbody> <tr> <td>11-7225 Bundle height approx. (cm)</td> <td style="text-align: center;">8</td> <td style="text-align: center;">9</td> <td style="text-align: center;">10</td> </tr> </tbody> </table>	Unit height up to (cm)	50	100	150	11-7225 Bundle height approx. (cm)	8	9	10
Unit height up to (cm)	50	100	150						
11-7225 Bundle height approx. (cm)	8	9	10						
Note:	Not possible for HEIM & HAUS skylights.								
Fabrics:	See MHZ Collection.								
Operation:	Open and close using operating rails. Rails secured at any desired position. An operating rod is optionally available for units difficult to reach.								
Installation:	Installation via skylight brackets. Screw the side guiding profiles to the side of the frame. See pages 100 - 101 for further accessories.								

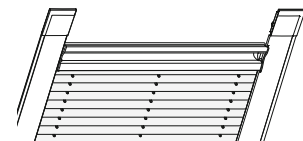
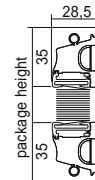
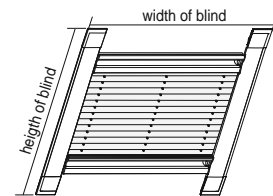

Technical data

Model 11-8550, 11-8551

Vertical special shapes, taut: Sloping windows

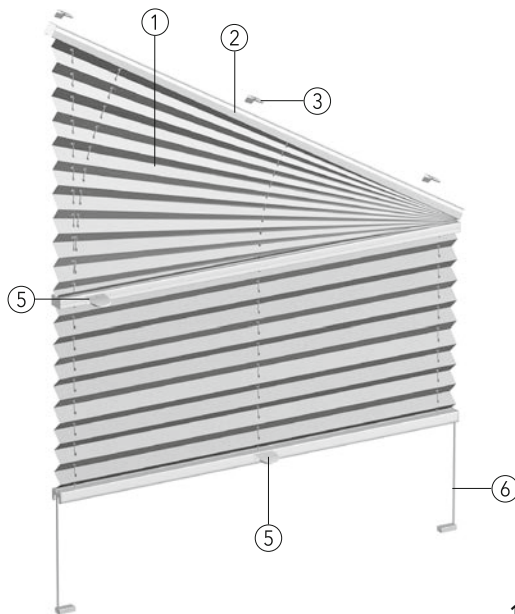
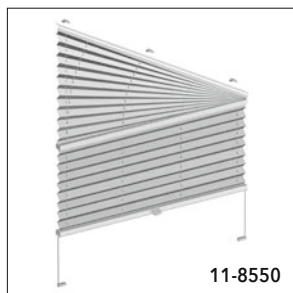

- ① Blind
- ② Head rail
- ③ Mounting clip
- ④ Angle bracket with clip
- ⑤ Operating rail with grip
- ⑥ Guide cord with footplate
- ⑦ Angle bracket with footplate

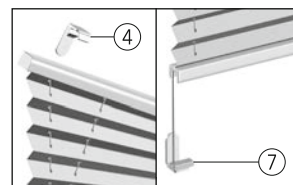

Technical data

Model:	<p>11-8550 Taut pleated blind for sloping windows with aperture angle of up to 60°, rectangular section of blind is movable, triangular section is fixed</p> <p>11-8551 Taut pleated blind for sloping windows with aperture angle of up to 35°, can be opened completely into the incline</p>												
Description:	<p>Height of blind can be adjusted by moving the operating rail. Head, central and bottom rail made of extruded aluminium. Pleated blind in various qualities, see MHZ collection. Colour of tension cords matches the blind. Particularly suitable for glazing bead installation for tilt & turn windows. Parallel blind guidance by means of laterally taut guide cord.</p>												
Dimensions:	<p>11-8550 min. width 30 cm, max. width 120 cm, max. height 220 cm</p> <p>11-8551 min. width 40 cm, max. width 120 cm, max. height 220 cm</p>												
Hardware colours:	<p>100 silver anodised E6/EV1 171 white powder-coated RAL 9016</p> <p>372 bronze anodised E6/3145 650 anthracite powder-coated similar to DB 703</p> <p>670 black powder-coated RAL 9005</p>												
Bundle heights:	<table border="1" style="width: 100%; border-collapse: collapse; text-align: center;"> <thead> <tr> <th style="text-align: left;">Unit height up to (cm)</th> <th>50</th> <th>100</th> <th>150</th> <th>200</th> <th>220</th> </tr> </thead> <tbody> <tr> <td style="text-align: left;">Bundle height approx. (cm)</td> <td>6</td> <td>7</td> <td>8</td> <td>9</td> <td>10</td> </tr> </tbody> </table>	Unit height up to (cm)	50	100	150	200	220	Bundle height approx. (cm)	6	7	8	9	10
Unit height up to (cm)	50	100	150	200	220								
Bundle height approx. (cm)	6	7	8	9	10								
Fabrics:	See MHZ Collection.												
Operation:	<p>Open and close by operating rail. Rail secured in any desired position. Model 11-8551 can be opened into the incline. Additional grip at the side on the centre profile.</p> <p>On model 11-8550 only the rectangular part of the blind can be opened and the triangular section is fixed.</p> <p>An operating rod is optionally available for units difficult to reach.</p>												
Special equipment:	Aluminium grip												
Installation:	<p>Ceiling installation (standard) with clip. Wall installation with angle or glazing bead brackets for front installation and clamp brackets (surcharge applies). 2 brackets up to a width of 64.9 cm, 3 brackets above a width of 65 cm.</p> <p>See pages 107 - 109 for brackets and accessories.</p>												
Note:	Due to its own weight, model 11-8551 cannot be fitted with the angled surface facing down.												

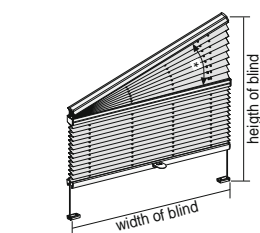

* Aperture angle
11-8550 max. 60°
11-8551 max. 35°

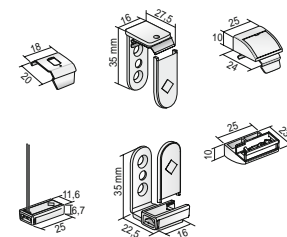
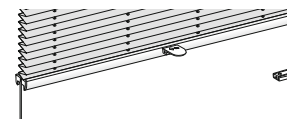
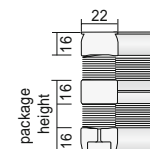

Model 11-8605, 11-8610

Vertical special shapes, taut: Round windows

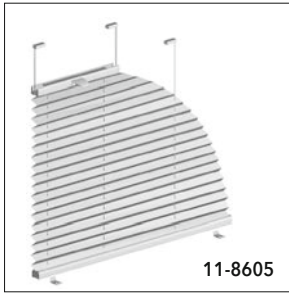

11-8605

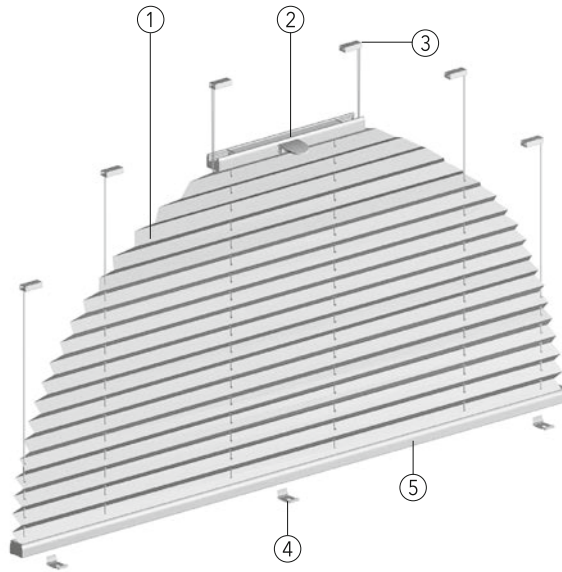

- ① Blind
- ② Operating rail with grip
- ③ Footplate
- ④ Mounting clip
- ⑤ Bottom rail

11-8610

Technical data

Model: 11-8605 Taut pleated blind, quadrant operable for round windows
11-8610 Taut pleated blind, semicircle operable for round windows

Description: Height of blind can be adjusted by moving the operating rail. Operating rail and bottom rail made of extruded aluminium. Pleated blind in various qualities, see MHZ collection. Colour of tension cords matches the blind. Min. width w equivalent to 1/3 of unit width.

Dimensions: 11-8605 Min. width 30 cm, max. width 120 cm, max. height 150 cm
11-8610 Min. width 30 cm, max. width 150 cm, max. height 150 cm

Hardware colours: 100 silver anodised E6/EV1 171 white powder-coated RAL 9016
372 bronze anodised E6/3145 650 anthracite powder-coated similar to DB 703
670 black powder-coated RAL 9005

Bundle heights:	Unit height up to (cm)	50	100	150
	Bundle height approx. (cm)	5	6	7

Note: Order only with template. (Specify finished size)
Expansion of the fabric is possible.

Fabrics: See MHZ Collection.

Operation: Open and close by operating rail. Rail secured in any desired position.
An operating rod is optionally available for units difficult to reach.

Special equipment: Aluminium grip
Swivel-mounted grip

Installation: Ceiling installation (standard) with clip and footplates. Wall installation with angle or glazing bead brackets (surcharge applies).
See pages 112 - 114 for brackets and accessories.

11-8605

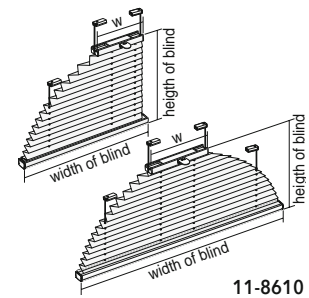

11-8610

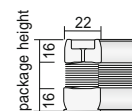

11-8605

11-8610

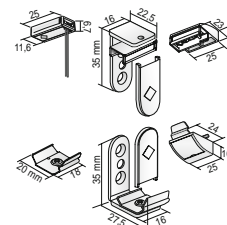
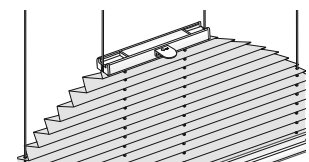
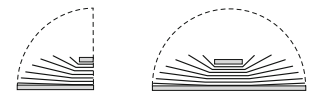

Technical data

Model 11-8722, 11-8723

Vertical special shapes, taut: triangular windows

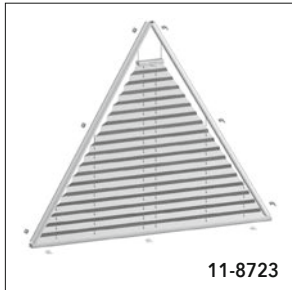

11-8723

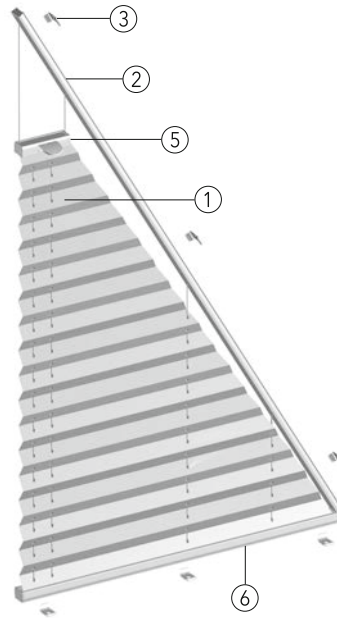
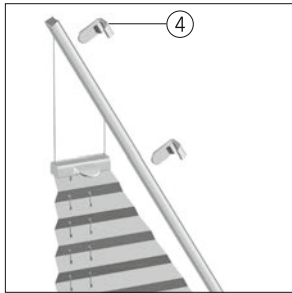

11-8722

- ① Blind
- ② Side rail
- ③ Mounting clip
- ④ Angle bracket with clip
- ⑤ Operating rail with grip
- ⑥ Bottom rail

Technical data

Model:	11-8722 Taut pleated blind for right-angled triangular windows 11-8723 Taut pleated blind for triangular windows										
Description:	Height of blind can be adjusted by moving the operating rail. Side, operating and bottom rails made of extruded aluminium. Pleated blind in various qualities, see MHZ collection. Colour of tension cords matches the blind. For technical reasons the peak remains uncovered on these models (min. width $w = 7$ cm).										
Dimensions:	Min. width 30 cm, max. width 120 cm, max. height 200 cm										
Hardware colours:	100 silver anodised E6/EV1 171 white powder-coated RAL 9016 372 bronze anodised E6/3145 650 anthracite powder-coated similar to DB 703 670 black powder-coated RAL 9005										
Bundle heights:	<table border="1" style="border-collapse: collapse; width: 100%;"> <thead> <tr> <th style="text-align: left;">Unit height up to (cm)</th> <th style="text-align: center;">50</th> <th style="text-align: center;">100</th> <th style="text-align: center;">150</th> <th style="text-align: center;">200</th> </tr> </thead> <tbody> <tr> <td style="text-align: left;">Bundle height approx. (cm)</td> <td style="text-align: center;">5</td> <td style="text-align: center;">6</td> <td style="text-align: center;">7</td> <td style="text-align: center;">8</td> </tr> </tbody> </table>	Unit height up to (cm)	50	100	150	200	Bundle height approx. (cm)	5	6	7	8
Unit height up to (cm)	50	100	150	200							
Bundle height approx. (cm)	5	6	7	8							
Note:	Expansion of the fabric is possible.										
Fabrics:	See MHZ Collection.										
Operation:	Open and close by operating rail. Rail secured in any desired position. An operating rod is optionally available for units difficult to reach.										
Special equipment:	Aluminium grip										
Installation:	Ceiling installation (standard) with clip. Wall installation with angle or glazing bead brackets for front installation (surcharge applies). 11 brackets per unit. See pages 119 - 120 for brackets and accessories.										

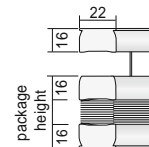
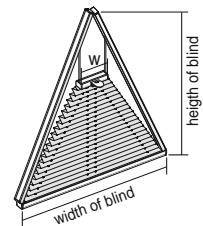

11-8722

11-8723

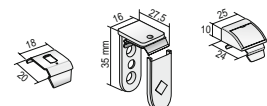
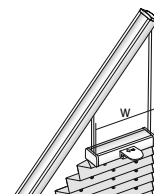
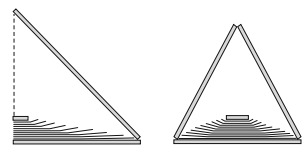

Model 11-8922, 11-8923

Vertical special shapes, taut: trapezoid windows



11-8923

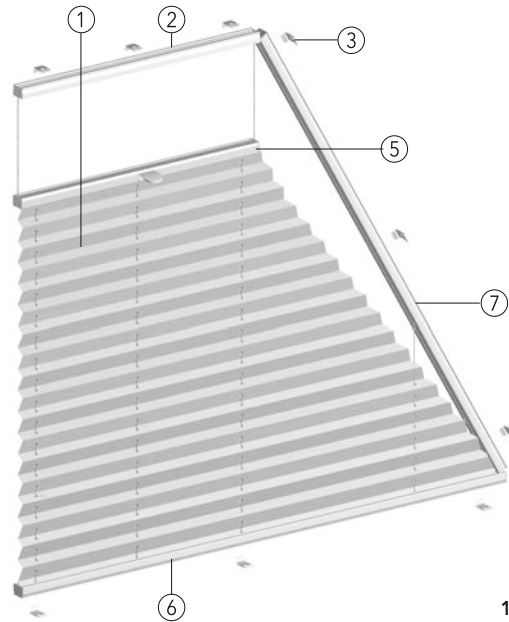
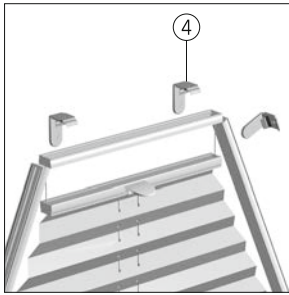

11-8922

- ① Blind
- ② Head rail
- ③ Mounting clip
- ④ Angle bracket with clip
- ⑤ Operating rail with grip
- ⑥ Bottom rail
- ⑦ Side rail

Technical data

Model:	11-8922 Taut pleated blind for trapezoid windows with a right angle 11-8923 Taut pleated blind for trapezoid windows										
Description:	Height of blind can be adjusted by moving the operating rail. Upper, side, operation and bottom rails made of extruded aluminium. Pleated blind in various qualities, see MHZ collection. Colour of tension cords matches the blind. Min. width w = 7 cm.										
Dimensions:	11-8922 min. width 30 cm, max. width 150 cm, max. height 200 cm max. distance (a) 120 cm 11-8923 min. width 30 cm, max. width 150 cm, max. height 200 cm										
Hardware colours:	100 silver anodised E6/EV1 171 white powder-coated RAL 9016 372 bronze anodised E6/3145 650 anthracite powder-coated similar to DB 703 670 black powder-coated RAL 9005										
Bundle heights:	<table border="1" style="border-collapse: collapse; width: 100%;"> <thead> <tr> <th style="text-align: left;">Unit height up to (cm)</th> <th style="text-align: center;">50</th> <th style="text-align: center;">100</th> <th style="text-align: center;">150</th> <th style="text-align: center;">200</th> </tr> </thead> <tbody> <tr> <td style="text-align: left;">Bundle height approx. (cm)</td> <td style="text-align: center;">5</td> <td style="text-align: center;">6</td> <td style="text-align: center;">7</td> <td style="text-align: center;">8</td> </tr> </tbody> </table>	Unit height up to (cm)	50	100	150	200	Bundle height approx. (cm)	5	6	7	8
Unit height up to (cm)	50	100	150	200							
Bundle height approx. (cm)	5	6	7	8							
Note:	Expansion of the fabric is possible.										
Fabrics:	See MHZ Collection.										
Operation:	Open and close by operating rail. Rail secured in any desired position. An operating rod is optionally available for units difficult to reach.										
Special equipment:	Aluminium grip										
Installation:	Ceiling installation (standard) with clip. Wall installation with angle or glazing bead brackets for front installation (surcharge applies). 11 brackets per unit. See pages 119 - 120 for brackets and accessories.										

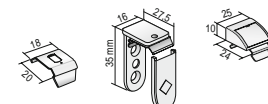
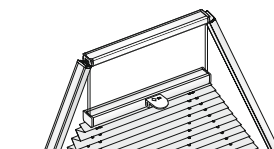
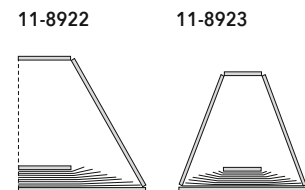
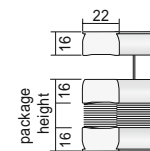
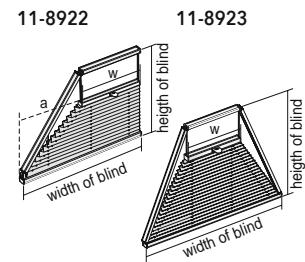

Technical data

Model 11-8422, 11-8433, 11-8823

Vertical special shapes, taut: pentagonal and hexagonal windows

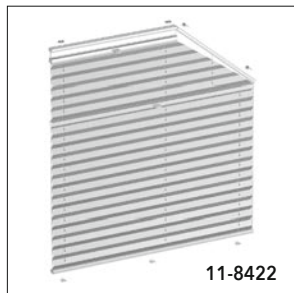

11-8422

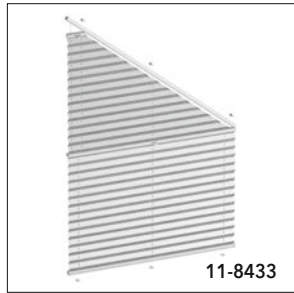

11-8433

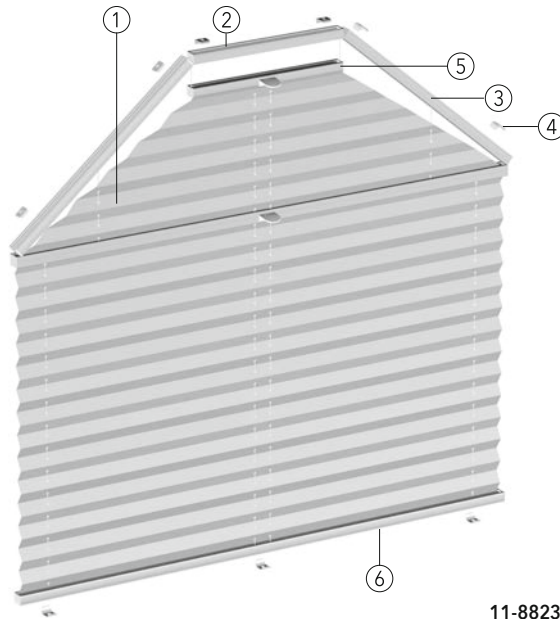

11-8823

- ① Blind
- ② Head rail
- ③ Side rail
- ④ Mounting clip
- ⑤ Operating rail with grip
- ⑥ Bottom rail
- ⑦ Angle bracket with clip

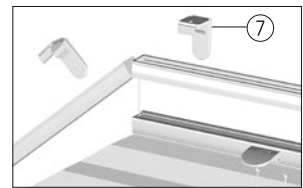

Technical data

Model: 11-8422 Taut pleated blind for pentagonal windows
 11-8433 Taut pleated blind for sloping windows
 11-8823 Taut pleated blind for hexagonal windows

Description: Height of blind can be adjusted by moving the operating rail. Upper, side, operation and bottom rails made of extruded aluminium. Pleated blind in various qualities, see MHZ collection. Colour of tension cords matches the blind. For technical reasons the peak on model 11-8433 remains uncovered (min. width $w = 7$ cm).

Dimensions: 11-8422 min. width 30 cm, max. width 120 cm, max. height 200 cm, from a width of 120.1 cm to 150 cm, max. height 150 cm, max. distance (a) 120 cm
 11-8433 min. width 30 cm, max. width 120 cm, max. height 200 cm, max. distance (a) 120 cm
 11-8823 min. width 30 cm, max. width 120 cm, max. height 200 cm, from a width of 120.1 cm to 150 cm, max. height 150 cm

Hardware colours: 100 silver anodised E6/EV1 171 white powder-coated RAL 9016
 372 bronze anodised E6/3145 650 anthracite powder-coated similar to DB 703
 670 black powder-coated RAL 9005

Bundle heights:	Unit height up to (cm)	50	100	150	200
	Bundle height approx. (cm)	7	8	9	10

Note: Expansion of the fabric is possible.

Fabrics: See MHZ Collection.

Operation: Open and close by operating rail. Rail secured in any desired position. An operating rod is optionally available for units difficult to reach.

Special equipment: Aluminium grip

Installation: Ceiling installation (standard) with clip. Wall installation with angle or glazing bead brackets for front installation (surcharge applies). 11 brackets per unit. See pages 125 - 126 for brackets and accessories.

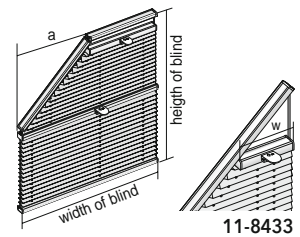

11-8433

11-8422, 11-8823 11-8433

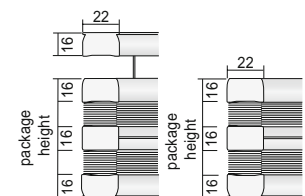

11-8422

11-8433

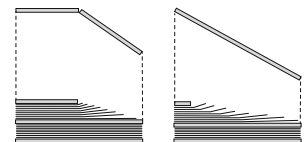

11-8823

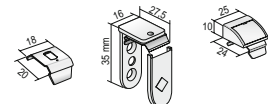
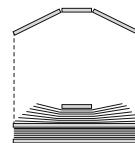

Model 11-8410, 11-8460

Vertical special shapes, free-hanging: Sloping windows

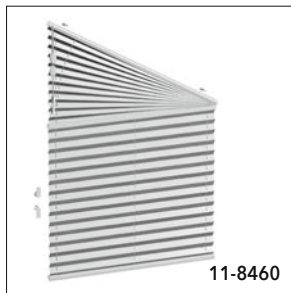

11-8460

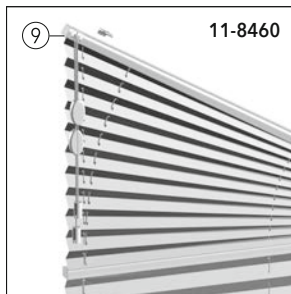

11-8460

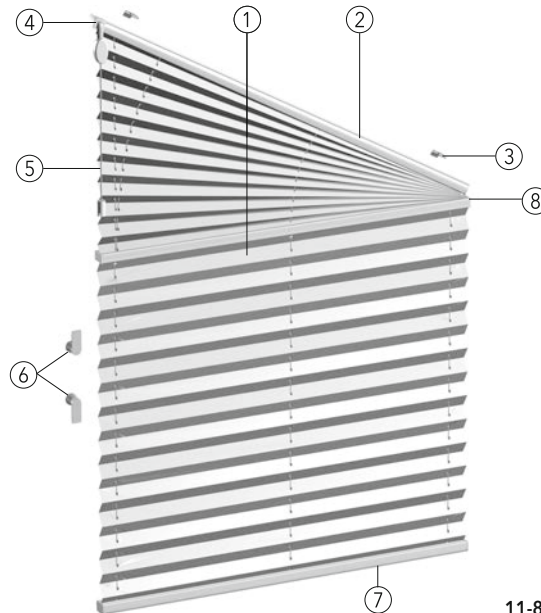

11-8410

- ① Blind
- ② Head rail
- ③ Mounting clip
- ④ Cord brake
- ⑤ Pull cord
- ⑥ Cord hook
- ⑦ Bottom rail
- ⑧ Band steel joint
- ⑨ Model 11-8460
2 pull cords at top

Technical data

Model:	<p>11-8410 Free-hanging pleated blind for sloping windows, aperture angle 5° to 35°, one pull cord, with joint and cord brake</p> <p>11-8460 Free-hanging pleated blind for sloping windows, aperture angle 5° to 60°, two pull cords at the top, without cord brakes, with band steel joint</p>												
Description:	Pull cord operation. Blind can also be opened when on a slant. Head, central and bottom rail made of extruded aluminium. Pleated blind in various qualities, see MHZ collection. Colour of pull cords matches the blind.												
Dimensions:	<p>11-8410 min. width 30 cm, max. width 100 cm, max. height 260 cm</p> <p>11-8460 min. width 30 cm, max. width 150 cm, max. height 260 cm</p>												
Hardware colours:	<table border="0"> <tr> <td>100 silver anodised E6/EV1</td> <td>171 white powder-coated RAL 9016</td> </tr> <tr> <td>372 bronze anodised E6/3145</td> <td>650 anthracite powder-coated similar to DB 703</td> </tr> <tr> <td>670 black powder-coated RAL 9005</td> <td></td> </tr> </table>	100 silver anodised E6/EV1	171 white powder-coated RAL 9016	372 bronze anodised E6/3145	650 anthracite powder-coated similar to DB 703	670 black powder-coated RAL 9005							
100 silver anodised E6/EV1	171 white powder-coated RAL 9016												
372 bronze anodised E6/3145	650 anthracite powder-coated similar to DB 703												
670 black powder-coated RAL 9005													
Bundle heights:	<table border="1"> <thead> <tr> <th>Unit height up to (cm)</th> <th>50</th> <th>100</th> <th>150</th> <th>200</th> <th>260</th> </tr> </thead> <tbody> <tr> <td>Bundle height approx. (cm)</td> <td>7</td> <td>8</td> <td>9</td> <td>10</td> <td>12</td> </tr> </tbody> </table>	Unit height up to (cm)	50	100	150	200	260	Bundle height approx. (cm)	7	8	9	10	12
Unit height up to (cm)	50	100	150	200	260								
Bundle height approx. (cm)	7	8	9	10	12								
Fabrics:	See MHZ Collection.												
Operation:	<p>11-8410 Raised and lowered using a pull cord, secured in position with cord brake, choice of operating side.</p> <p>11-8460 Lift and lower with 2 pull cords without cord brakes. The blind is secured in position by wrapping the cord around the cord hooks. Top operating side. Standard operation length (L) 100 cm, other heights available on request. Cord hooks included.</p>												
Child safety:	The safety tassel for child safety comes pre-installed on the cord. After operation, the pull cord and safety tassel must be wrapped around the cord hook.												
Installation:	Ceiling installation (standard) with clip. Wall installation with angle or glazing bead brackets for front installation and clamp brackets (surcharge applies). Up to a width of 99.9 cm 2 brackets, above a width of 100 cm 3 brackets. See pages 131 - 132 for brackets and accessories.												

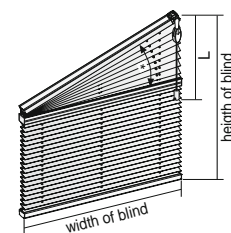

* Aperture angle
11-8410 max. 35°
11-8460 max. 60°

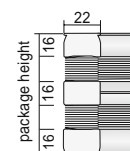

11-8410

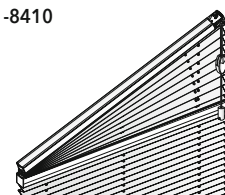

11-8460

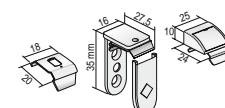
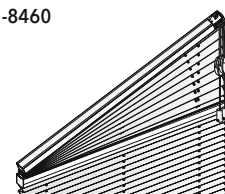

Technical data

Model 11-8465, 11-8470

Vertical special shapes, free-hanging: Sloping windows

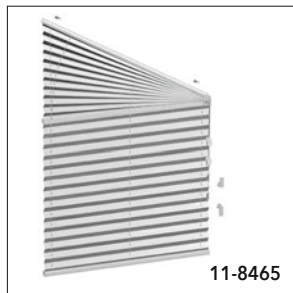

11-8465

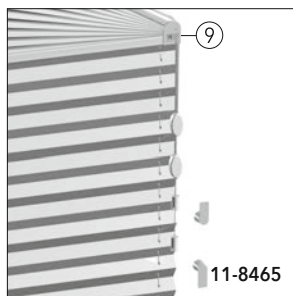

11-8465

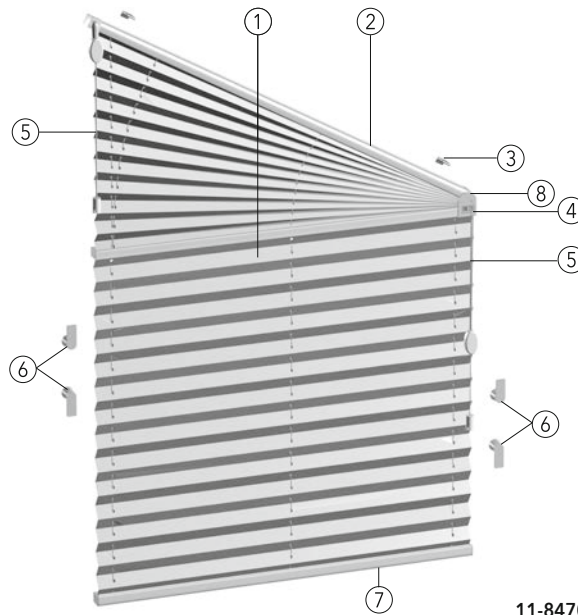

11-8470

- ① Blind
- ② Head rail
- ③ Mounting clip
- ④ Cord brake
- ⑤ Pull cord
- ⑥ Cord hook
- ⑦ Bottom rail
- ⑧ Joint
- ⑨ Model 11-8465
2 pull cords at bottom

Technical data

Model: **11-8465** Free-hanging pleated blind for sloping windows, aperture angle 5° to 60°, two pull cords at the bottom, with joint, vertical area with cord brake, triangular area without cord brake
11-8470 Free-hanging pleated blind for sloping windows, aperture angle 5° to 60°, with two pull cords (one on each side) with joint and cord brakes

Description: Pull cord operation. Blind can also be opened when on a slant. Head, central and bottom rail made of extruded aluminium. Pleated blind in various qualities, see MHZ collection. Colour of pull cords matches the blind.

Dimensions: Min. width 30 cm, max. width 150 cm, max. height 260 cm

Hardware colours: 100 silver anodised E6/EV1 171 white powder-coated RAL 9016
 372 bronze anodised E6/3145 650 anthracite powder-coated similar to DB 703
 670 black powder-coated RAL 9005

Bundle heights:	Unit height up to (cm)	50	100	150	200	260
	Bundle height approx. (cm)	7	8	9	10	12

Fabrics: See MHZ Collection.

Operation: **11-8465** Lift and lower with 2 pull cords, vertical area secured in position via cord brake, triangular area without cord brake, secured in position by wrapping the cord around the cord hooks, bottom operating side.
11-8470 Lift and lower with a pull cord, secured in position via the cord brake. Top and bottom operating side.
 Standard operation length (L) 100 cm, other heights available on request.
 Cord hooks included.

Child safety: The safety tassel for child safety comes pre-installed on the cord. After operation, the pull cord and safety tassel must be wrapped around the cord hook.

Installation: Ceiling installation (standard) with clip. Wall installation with angle or glazing bead brackets for front installation and clamp brackets (surcharge applies). Up to a width of 99.9 cm 2 brackets, above a width of 100 cm 3 brackets. See pages 131 - 132 for brackets and accessories.

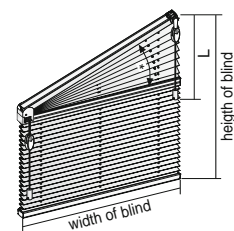

* Max. aperture angle 60°

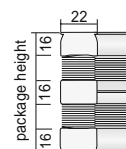

11-8465

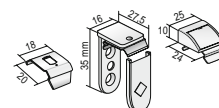
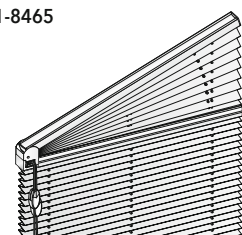

Model 11-8710, 11-8780

Vertical special shapes, free-hanging: Triangular windows

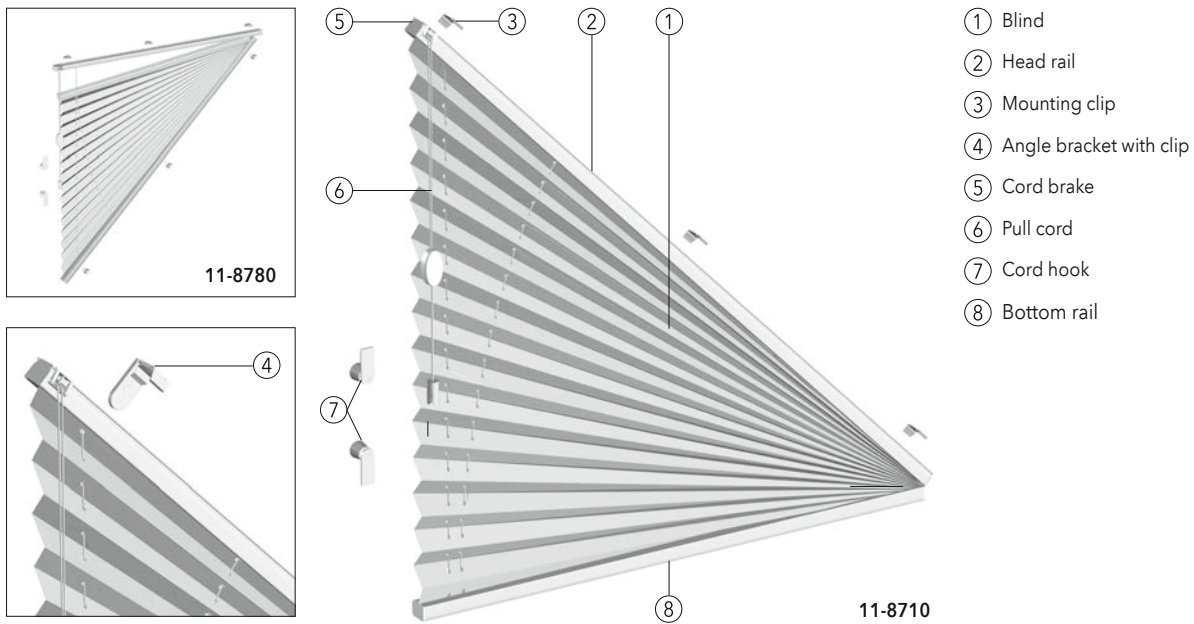

Technical data

Model:	11-8710 Free-hanging pleated blind with pull cord for triangular windows, aperture angle 5° to 60°, blind opens upwards 11-8780 Free-hanging pleated blind with pull cord for triangular windows, aperture angle 5° to 45°, blind opens downwards									
Description:	Pull cord operation with integrated lateral cord brake. Head rail and bottom rail made of extruded aluminium. Pleated blind in various qualities, see MHZ collection. Colour of pull cords matches the blind.									
Dimensions:	11-8710 min. width 50 cm, max. width 150 cm, max. height 150 cm 11-8780 min. width 50 cm, max. width 150 cm, max. height 100 cm									
Hardware colours:	100 silver anodised E6/EV1 171 white powder-coated RAL 9016 372 bronze anodised E6/3145 650 anthracite powder-coated similar to DB 703 670 black powder-coated RAL 9005									
Bundle heights:	<table border="1" style="border-collapse: collapse; width: 100%;"> <thead> <tr> <th>Unit height up to (cm)</th> <th>50</th> <th>100</th> </tr> </thead> <tbody> <tr> <td>11-8710 Bundle height approx. (cm)</td> <td>5</td> <td>6</td> </tr> <tr> <td>11-8780 Bundle height approx. (cm)</td> <td>6</td> <td>7</td> </tr> </tbody> </table>	Unit height up to (cm)	50	100	11-8710 Bundle height approx. (cm)	5	6	11-8780 Bundle height approx. (cm)	6	7
Unit height up to (cm)	50	100								
11-8710 Bundle height approx. (cm)	5	6								
11-8780 Bundle height approx. (cm)	6	7								
Note:	Expansion of the fabric is possible.									
Fabrics:	See MHZ Collection.									
Operation:	Lift and lower with a pull cord, secured in position via the cord brake. Operating side left or right. With model 11-8710 operation is only possible at the high side. Standard operation length (L) 100 cm, other heights available on request. Cord hooks included.									
Child safety:	The safety tassel for child safety comes pre-installed on the cord. After operation, the pull cord and safety tassel must be wrapped around the cord hook.									
Installation:	Ceiling installation (standard) with clip. Wall installation with angle or glazing bead brackets for front installation or clamp brackets (surcharge applies). With 11-8710 3 brackets per unit. With 11-8780 6 brackets per unit. See pages 136 - 137 for brackets and accessories.									

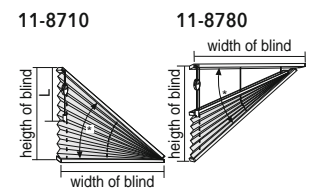

* Aperture angle
11-8710 max. 60° | **11-8780** max. 45°

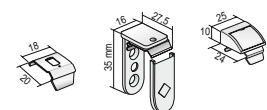
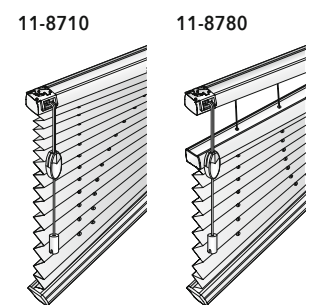
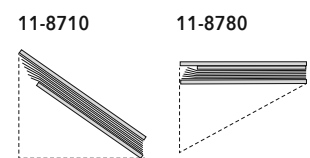
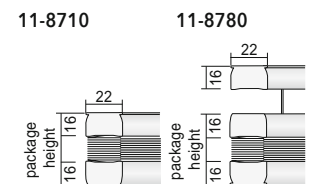

Model 11-8700, 11-8709, 11-8600

Fixed vertical special shapes: semicircular arches and triangular windows

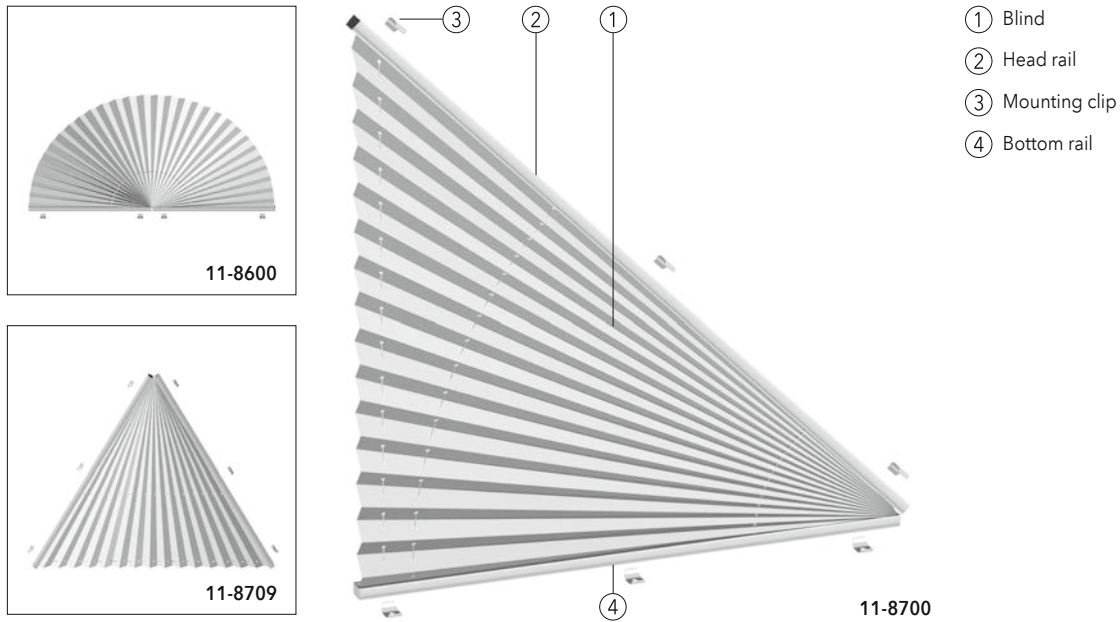

Technical data

Model:	11-8700 Fixed pleated blind for right-angled triangular windows 11-8709 Fixed pleated blind for triangular windows 11-8600 Fixed pleated blind for round windows up to 180°
Description:	Fixed blind. Head rail and bottom rail made of extruded aluminium. Pleated blind in various qualities, see MHZ collection. Only for fixed glazing.
Dimensions:	11-8700 min. width 30 cm, max. width 150 cm, max. height 150 cm 11-8709 min. width 30 cm, max. width 100 cm, max. height 150 cm 11-8600 up to 90°: min. width 30 cm, max. width 100 cm, max. height 100 cm up to 180°: min. width 30 cm, max. width 100 cm, max. height 50 cm
Hardware colours:	100 silver anodised E6/EV1 171 white powder-coated RAL 9016 372 bronze anodised E6/3145 650 anthracite powder-coated similar to DB 703 670 black powder-coated RAL 9005
Fabrics:	See MHZ Collection.
Installation:	Ceiling installation (standard) with clip. Wall installation with angle or glazing bead brackets for front installation (surcharge applies). With model 11-8700 , 11-8709 6 brackets per unit. With 11-8600 3 brackets per unit. See pages 136 - 137 for brackets and accessories.

11-8700

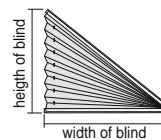

11-8709

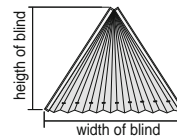

11-8600, 90°

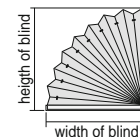

11-8600, 180°

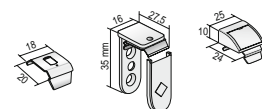
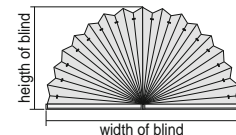

Model 11-6120, 11-6110

Ceiling and conservatory blinds: Operating rail, pull cord

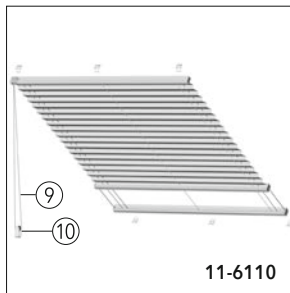

11-6110

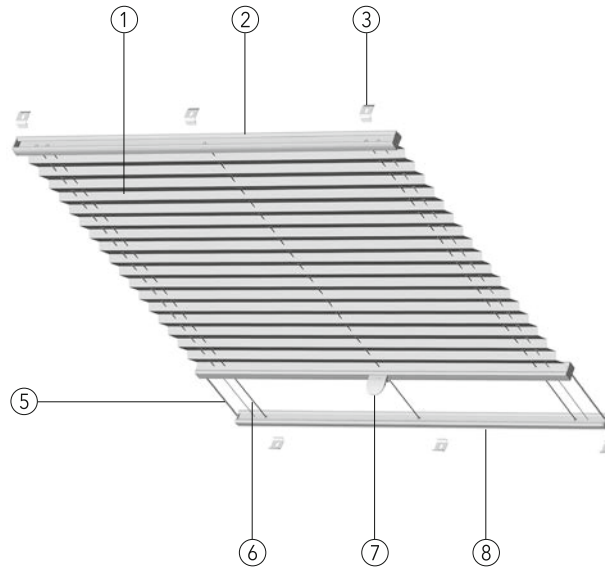
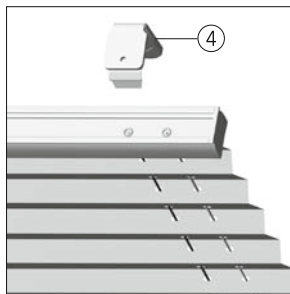

- ① Blind
- ② Head rail
- ③ Mounting clip
- ④ Angle bracket with clip
- ⑤ Tension wire
- ⑥ Tension cord
- ⑦ Operating rail with grip
- ⑧ Bottom rail
- ⑨ Operation cord
- ⑩ Safety tensioner

11-6120

Technical data

Model:	<p>11-6120 Taut pleated blind for ceilings and conservatories. Height of blind can be adjusted by moving the operating rail.</p> <p>11-6110 Pleated blind with pull cord for ceilings and conservatories. Endless cord operation.</p>											
Description:	Head, operating and bottom rail made of extruded aluminium. Pleated blind in various qualities, see MHZ collection. Black-coated tension wires guide the pleated blind parallel to the window. Colour of tension cords on 11-6110 grey, on 11-6120 anthracite.											
Dimensions:	Min. width 30 cm, max. width 150 cm, max. height 400 cm											
Hardware colours:	<table border="0"> <tr> <td>100 silver anodised E6/EV1</td> <td>171 white powder-coated RAL 9016</td> </tr> <tr> <td>372 bronze anodised E6/3145</td> <td>650 anthracite powder-coated similar to DB 703</td> </tr> <tr> <td>670 black powder-coated RAL 9005</td> <td></td> </tr> </table>	100 silver anodised E6/EV1	171 white powder-coated RAL 9016	372 bronze anodised E6/3145	650 anthracite powder-coated similar to DB 703	670 black powder-coated RAL 9005						
100 silver anodised E6/EV1	171 white powder-coated RAL 9016											
372 bronze anodised E6/3145	650 anthracite powder-coated similar to DB 703											
670 black powder-coated RAL 9005												
Bundle heights:	<table border="1" style="width: 100%; border-collapse: collapse;"> <thead> <tr> <th style="text-align: left;">Unit height up to (cm)</th> <th style="text-align: center;">100</th> <th style="text-align: center;">200</th> <th style="text-align: center;">300</th> <th style="text-align: center;">400</th> </tr> </thead> <tbody> <tr> <td style="text-align: left;">Bundle height approx. (cm)</td> <td style="text-align: center;">6</td> <td style="text-align: center;">8</td> <td style="text-align: center;">10</td> <td style="text-align: center;">12</td> </tr> </tbody> </table>	Unit height up to (cm)	100	200	300	400	Bundle height approx. (cm)	6	8	10	12	
Unit height up to (cm)	100	200	300	400								
Bundle height approx. (cm)	6	8	10	12								
Fabrics:	See MHZ Collection.	11-6120										
Operation:	<p>11-6120 Open and close via operating rail. Blind secured in any desired position. An operating rod is optionally available for units difficult to reach.</p> <p>11-6110 Open and close via endless cord. Blind secured in any desired position. Operating side left or right. Operation length (L) from 50 cm to 150 cm in 10 cm increments (standard 100 cm), operation length from 150.1 cm to 300 cm in 25 cm increments. Other operation lengths available on request (surcharge applies). Please also note information on page 214.</p>											
Child safety:	11-6110 The safety tensioner is supplied pre-fitted on the cord. Be sure to fit in correct direction and keep the cord taut. Correct positioning of the safety tensioner must be checked regularly and, in the case of doubt, re-adjusted.	11-6110										
Installation:	Ceiling installation (standard) with clip. Wall installation with angle brackets (surcharge applies). Mounting profile for the required distance to the glass pane (refer to page 214 - installation recommendations). See pages 145 - 146 for brackets and accessories.											
Note:	Blind must run from top to bottom.											

Technical data

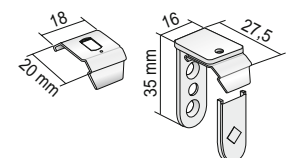

Model 11-6130, 11-6140

Ceiling and conservatory blinds: crank handle, electric operating rod, electric drive 24 V

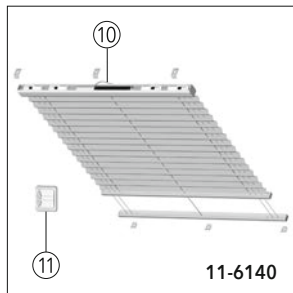

11-6140

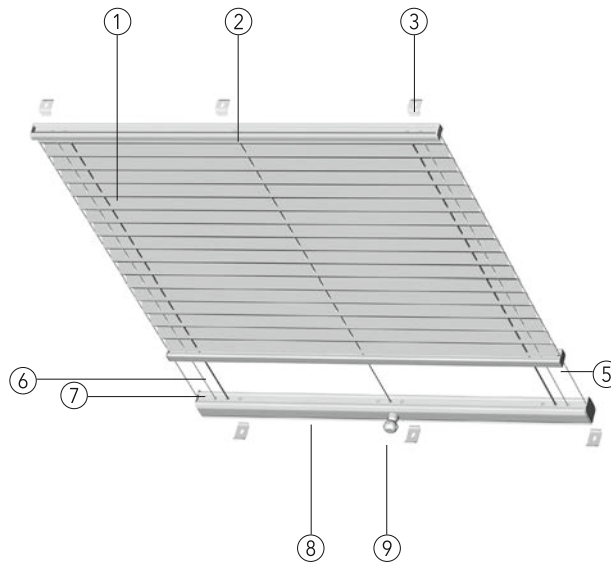
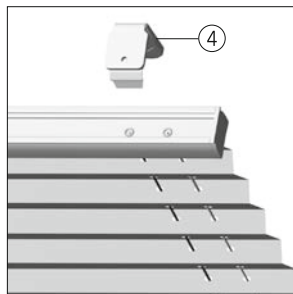

- ① Blind
- ② Head or bottom rail
- ③ Mounting clip
- ④ Angle bracket with clip
- ⑤ Operating rail
- ⑥ Tension wire
- ⑦ Tension cord
- ⑧ Drive rail
- ⑨ Drive adapter
- ⑩ Electric drive 24 V
- ⑪ Switch combination (not included)

11-6130

Technical data

Model: **11-6130** Pleated blind with crank handle or electric operating rod for ceilings and conservatories
11-6140 Pleated blind with electric drive 24 V in the middle of the head rail, with automatic end position switch-off. Single or group operation. Suitable for damp locations (DIN EN 13120, L1 and max. L2, i.e. well-heated and ventilated living spaces that are not overcrowded, including kitchens and bathrooms)

Description: Profiles made of extruded aluminium. Pleated blind in various qualities, 'see MHZ collection. Black-coated tension wires guide the pleated blind parallel to the window. Colour of tension cords grey.

Dimensions: **11-6130** Min. width 40 cm, max. width 150 cm, max. height 400 cm
11-6140 Min. width 55 cm, max. width 69.9 cm, max. height 240 cm, min. width 70 cm, max. width 150 cm, max. height 400 cm

Hardware colours: 100 silver anodised E6/EV1 171 white powder-coated RAL 9016
 372 bronze anodised E6/3145 650 anthracite powder-coated similar to DB 703
 670 black powder-coated RAL 9005

Bundle heights:	Unit height up to (cm)	100	200	300	400
	Bundle height approx. (cm)	9	11	13	15

Fabrics: See MHZ Collection.

Operation: **11-6130** Open and close via crank handle or electric operating rod, see Electrical Accessories Price List. Drive adapter in the middle, other positions on request.
 Standard: Operation and fabric package on opposite side ⁽¹⁾, different arrangement on request.

11-6140 Open and close via electric drive ⁽²⁾. Various control options provided by lock switch, radio remote control, timer and light sensor. For prices, information, control options and accessories, see the Electrical Accessories Price List.

Installation: Ceiling installation (standard) with clip. Wall installation with angle bracket (surcharge applies). Mounting profile for the required distance to the glass pane (see page 214 - Installation recommendations). See pages 153 - 155 for bracket quantities and accessories.

Note: **11-6130** Unit must run from top to bottom
11-6140 ⁽²⁾ Electric drive and fabric package are always built together, blind must run at an angle from top to bottom.

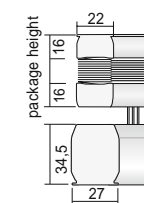
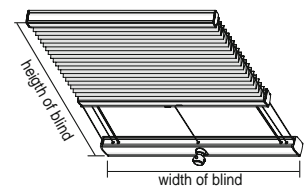

11-6130 ⁽¹⁾

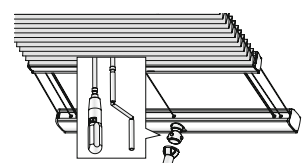

11-6140 ⁽²⁾

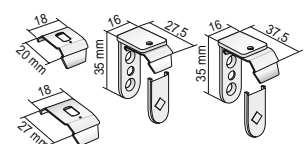
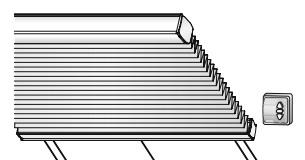

Model 11-6556

Special shapes with tension wires: Sloping windows

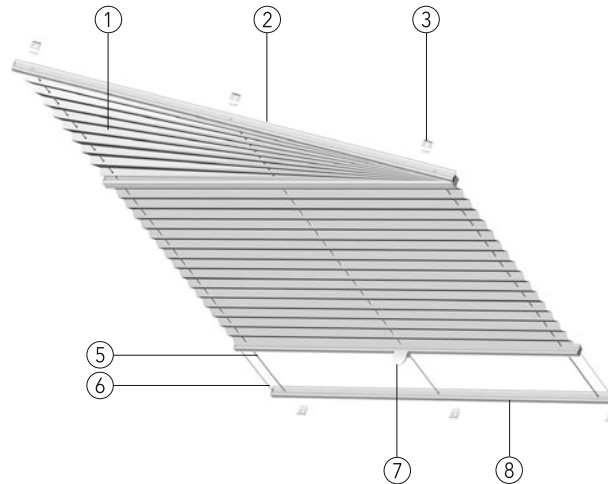
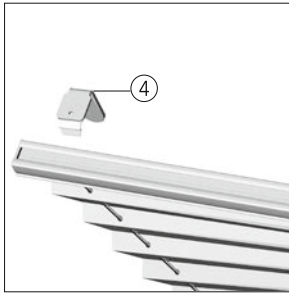

- ① Blind
- ② Head rail
- ③ Mounting clip
- ④ Angle bracket with clip
- ⑤ Tension wire
- ⑥ Tension cord
- ⑦ Operating rail with grip
- ⑧ Bottom rail

11-6556

Technical data

Model:	11-6556 Taut pleated blind as a sloping unit for ceilings and conservatories, angle up to max. 60°		
Description:	Height of blind can be adjusted by moving the operating rail. Fixed triangular area, rectangular area of the blind movable. Head, central, operating and bottom rail made of extruded aluminium. Pleated blind in various qualities, see MHZ collection. Colour of tension cords matches the blind. Black-coated tension wires guide the pleated blind parallel to the window.		
Dimensions:	Min. width 30 cm, max. width 120 cm, max. angled width 230 cm, max. height 400 cm Inclination angle: 45° - 90°		
Hardware colours:	100 silver anodised E6/EV1	171 white powder-coated RAL 9016	
	372 bronze anodised E6/3145	650 anthracite powder-coated similar to DB 703	
	670 black powder-coated RAL 9005		
Bundle heights:	Unit height up to (cm)	100	200
	Bundle height approx. (cm)	6	8
Fabrics:	See MHZ Collection.		
Operation:	Open and close by operating rail. Rail secured in any desired position. Only the rectangular part of the blind can be opened. An operating rod is optionally available for units difficult to reach.		
Installation:	Ceiling installation (standard) with clip. Wall installation with angle brackets (surcharge applies). Mounting profile for the required distance to the glass pane (see page 214 - Installation recommendations). See pages 160 - 161 for bracket quantities and accessories. Bracket installation 10 cm from the outside.		

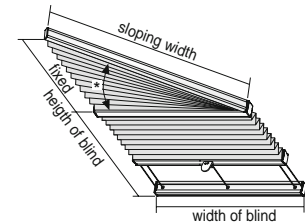

* max. aperture angle 60°

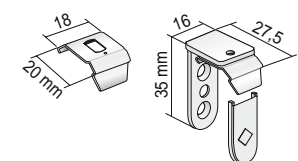
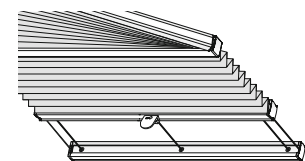
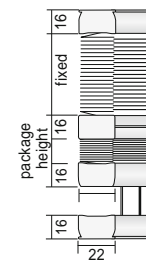

Technical data

Model 11-6722, 11-6723

Special shapes with tension wires: triangular windows

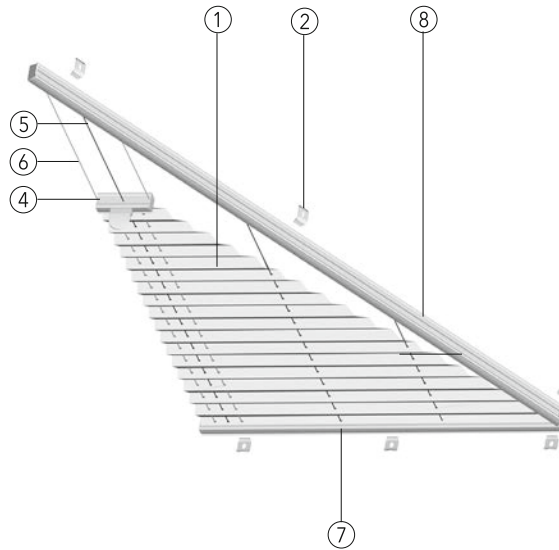
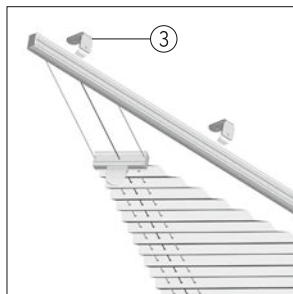

- ① Blind
- ② Mounting clip
- ③ Angle bracket with clip
- ④ Operating rail with grip
- ⑤ Tension wire
- ⑥ Tension cord
- ⑦ Bottom rail
- ⑧ Side rail

11-6722

Technical data

Model:	11-6722 Taut pleated blind as a triangular unit with a right angle for ceilings and conservatories										
	11-6723 Taut pleated blind as a triangular unit for ceilings and conservatories										
Description:	Height of blind can be adjusted by moving the operating rail. Upper, side, operation and bottom rails made of extruded aluminium. Pleated blind in various qualities, see MHZ collection. Colour of tension cords matches the blind. Black-coated tension wires guide the pleated blind parallel to the window. For technical reasons, the peak remains uncovered (minimum width w = 7 cm).										
Dimensions:	11-6722 min. width 30 cm, max. width 120 cm, max. height 200 cm, max. distance (a) 120 cm 11-6723 min. width 30 cm, max. width 120 cm, max. height 200 cm										
Hardware colours:	100 silver anodised E6/EV1 171 white powder-coated RAL 9016 372 bronze anodised E6/3145 650 anthracite powder-coated similar to DB 703 670 black powder-coated RAL 9005										
Bundle heights:	<table border="1" style="border-collapse: collapse; width: 100%; text-align: center;"> <thead> <tr> <th>Unit height up to (cm)</th> <th>50</th> <th>100</th> <th>150</th> <th>200</th> </tr> </thead> <tbody> <tr> <td>Bundle height approx. (cm)</td> <td>4</td> <td>5</td> <td>6</td> <td>7</td> </tr> </tbody> </table>	Unit height up to (cm)	50	100	150	200	Bundle height approx. (cm)	4	5	6	7
Unit height up to (cm)	50	100	150	200							
Bundle height approx. (cm)	4	5	6	7							
Note:	Expansion of the fabric is possible.										
Fabrics:	See MHZ Collection.										
Operation:	Open and close by operating rail. Rail secured in any desired position. An operating rod is optionally available for units difficult to reach.										
Installation:	Ceiling installation (standard) with clip. Wall installation with angle brackets (surcharge applies). 11 brackets per unit. Mounting profile for the required distance to the glass pane (refer to page 214 - installation recommendations). See pages 165 - 166 for brackets and accessories.										

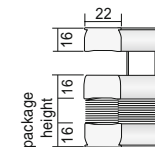
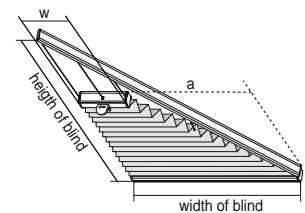

11-6722 11-6723

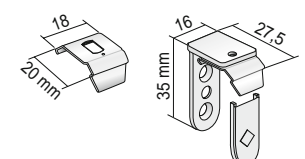
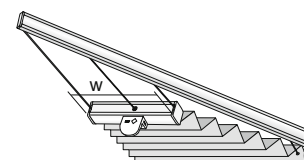
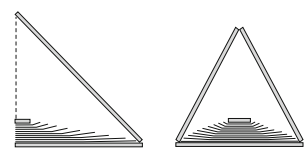

Model 11-6922, 11-6923

Special shapes with tension wires: trapezoid windows

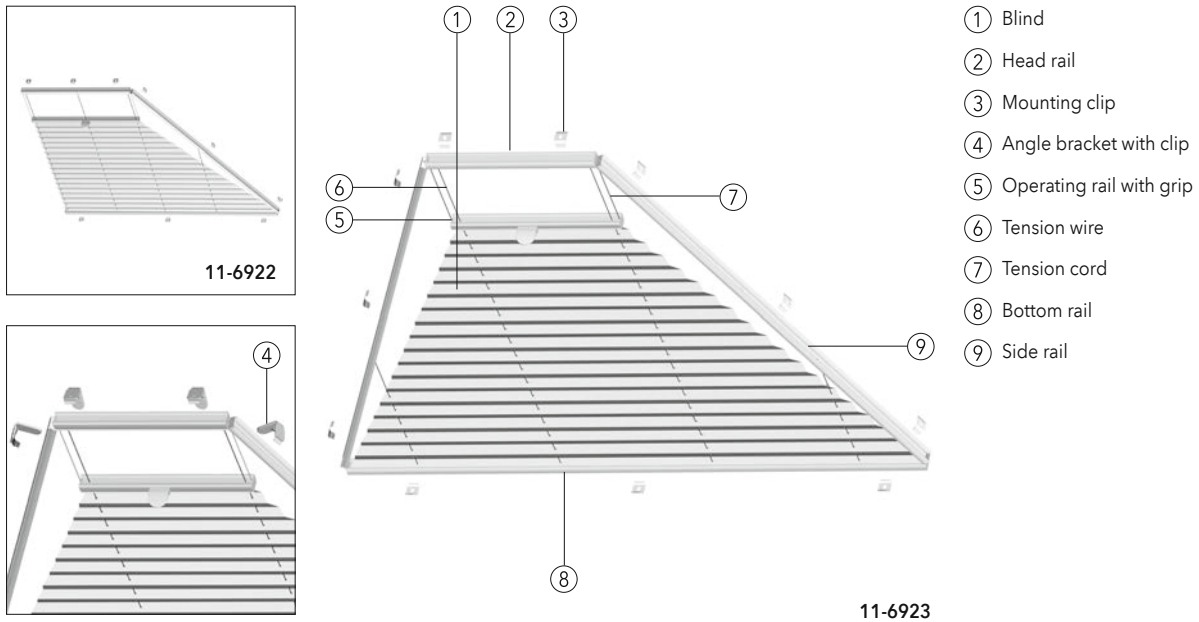

- ① Blind
- ② Head rail
- ③ Mounting clip
- ④ Angle bracket with clip
- ⑤ Operating rail with grip
- ⑥ Tension wire
- ⑦ Tension cord
- ⑧ Bottom rail
- ⑨ Side rail

Technical data

Model:	11-6922 Taut pleated blind as a trapezoidal unit with a right angle for ceilings and conservatories 11-6923 Taut pleated blind as a trapezoidal unit for ceilings and conservatories										
Description:	Height of blind can be adjusted by moving the operating rail. Upper, side, operation and bottom rails made of extruded aluminium. Pleated blind in various qualities, see MHZ collection. Colour of tension cords matches the blind. Black-coated tension wires guide the pleated blind parallel to the window. Min. width $w = 10$ cm.										
Dimensions:	11-6922 min. width 30 cm, max. width 120 cm, max. height 200 cm, max. distance (a) 120 cm 11-6923 min. width 30 cm, max. width 150 cm, max. height 200 cm										
Hardware colours:	100 silver anodised E6/EV1 171 white powder-coated RAL 9016 372 bronze anodised E6/3145 650 anthracite powder-coated similar to DB 703 670 black powder-coated RAL 9005										
Bundle heights:	<table border="1" style="border-collapse: collapse; width: 100%; text-align: center;"> <thead> <tr> <th style="text-align: left;">Unit height up to (cm)</th> <th>50</th> <th>100</th> <th>150</th> <th>200</th> </tr> </thead> <tbody> <tr> <td style="text-align: left;">Bundle height approx. (cm)</td> <td>4</td> <td>5</td> <td>6</td> <td>7</td> </tr> </tbody> </table>	Unit height up to (cm)	50	100	150	200	Bundle height approx. (cm)	4	5	6	7
Unit height up to (cm)	50	100	150	200							
Bundle height approx. (cm)	4	5	6	7							
Note:	Expansion of the fabric is possible.										
Fabrics:	See MHZ Collection.										
Operation:	Open and close by operating rail. Rail secured in any desired position. An operating rod is optionally available for units difficult to reach.										
Installation:	Ceiling installation (standard) with clip. Wall installation with angle brackets (surcharge applies). 11 brackets per unit. Mounting profile for the required distance to the glass pane (refer to page 214 - installation recommendations). See pages 165 - 166 for brackets and accessories.										

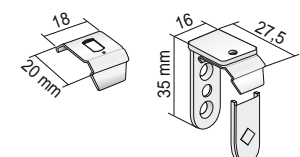
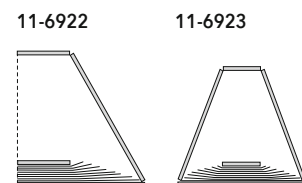
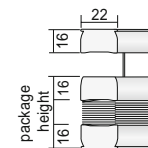
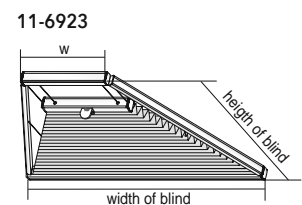
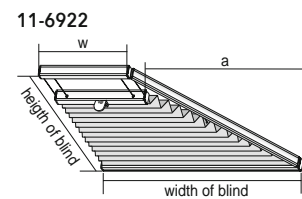

Technical data

Model 11-6422, 11-6433, 11-6823

Special shapes with tension wires: pentagonal and hexagonal windows

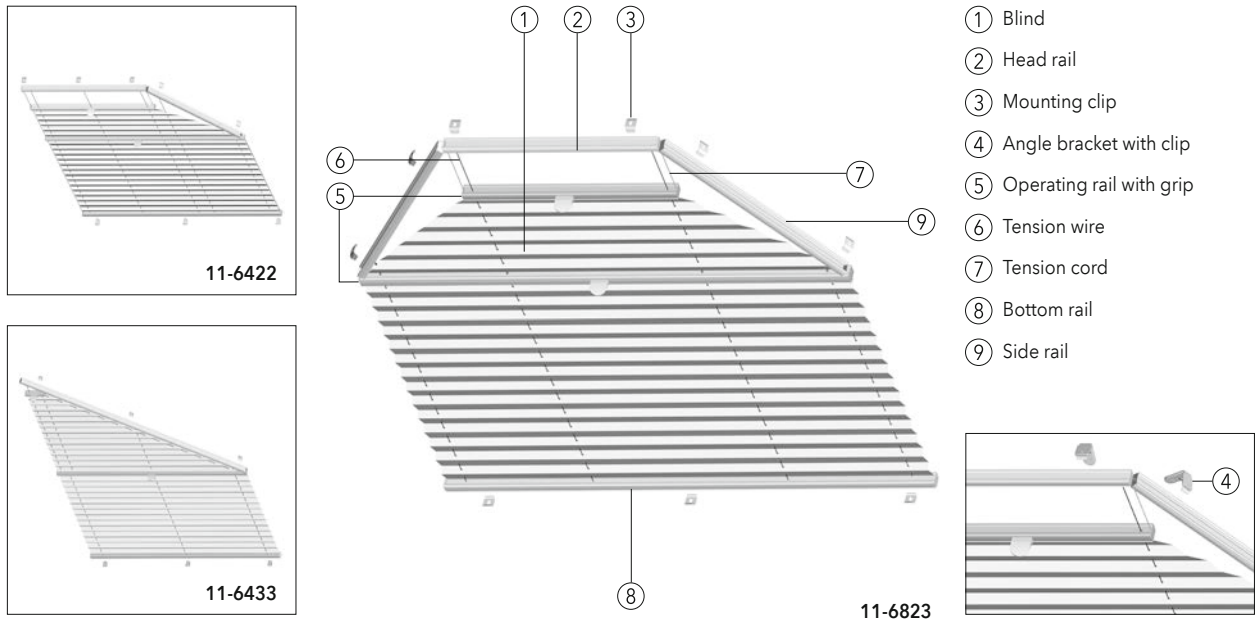

Technical data

Model: 11-6422 Taut pleated blind as a pentagonal unit for ceilings and conservatories
 11-6433 Taut pleated blind as a sloping unit for ceilings and conservatories
 11-6823 Taut pleated blind as a hexagonal unit for ceilings and conservatories

Description: Height of blind can be adjusted by moving the operating rail. Upper, side, operation and bottom rails made of extruded aluminium. Pleated blind in various qualities, see MHZ collection. Colour of tension cords matches the blind. Black-coated tension wires guide the pleated blind parallel to the window. For technical reasons the peak on model 11-6433 remains uncovered (min. width $w = 10$ cm)

Dimensions: 11-6422 min. width 30 cm, max. width 150 cm, max. height 400 cm
 11-6433 min. width 30 cm, max. width 120 cm, max. height 400 cm
 11-6823 min. width 30 cm, max. width 150 cm, max. height 400 cm

Hardware colours: 100 silver anodised E6/EV1 171 white powder-coated RAL 9016
 372 bronze anodised E6/3145 650 anthracite powder-coated similar to DB 703
 670 black powder-coated RAL 9005

Bundle heights:	Unit height up to (cm)	50	100	200	300	400
	Bundle height approx. (cm)	7	9	11	13	15

Note: Expansion of the fabric is possible.

Fabrics: See MHZ Collection.

Operation: Open and close by operating rail.
 Rail secured in any desired position.
 An operating rod is optionally available for units difficult to reach.

Installation: Ceiling installation (standard) with clip. Wall installation with angle brackets (surcharge applies). 11 brackets per unit. Mounting profile for the required distance to the glass pane (refer to page 214 - installation recommendations). See pages 173 - 175 for brackets and accessories.

